



PROMODAY 2026

PORTUGAL € IVA ÑAO INCLUIDA



MEMODERIVA[®]
MAQUINAS & EQUIPAMENTOS INDUSTRIAIS

IMPORTADOR EXCLUSIVO



PROMODAY 2026

FASANOTOOLS.COM





02 — CHAVES DE APERTO

06 — CHAVES DE CAIXAS

12 — CHAVES DE FENDA E ALICATES

16 — ELETRÔNICA E ELETROTÉCNICA

18 — CHAVES DINAMOMETRICAS

20 — FERRAMENTAS DE CORTE

22 — MANUTENÇÃO GENERAL

28 — ILUMINAÇÃO

36 — POWER TOOLS

42 — EXTRACTORES

44 — FERRAMENTAS DE AR

52 — CARROS E BANCOS

92 — MOBÍLIA TÉCNICA

106 — MOBILIÁRIO PARA VANS

110 — AUTOMOTIVE

132 — PROFESSIONAL EQUIPMENT



CHAVES DE APERTO



INDUSTRIAL

CHAVE POLIGONAL DE BOCA/LUNETA

FG 600/A

DESIGN DE CABEÇA OTIMIZADO
Para uma elevada força de fixação

ALTO DESEMPENHO
Atinge valores de binário duas vezes superiores ao padrão

CABEÇA POLIGONAL DESLOCADA
Inclinado 15° para aceder às porcas e parafusos embutidos na superfície de trabalho e proteger a mão do utilizador



FG 600A/SC16

€/LISTA
~~250,00~~

PROMO
159,00€

JOGOS CHAVES DE BOCA/LUNETAS POLIGONAIS - INDUSTRIAL
Conteúdo: 6, 7, 8, 10, 12, 13, 14, 16, 17, 19, 21, 22, 24, 27, 30, 32mm

FG 600A/SC25

€/LISTA
~~415,00~~

PROMO
249,00€

JOGOS CHAVES DE BOCA/LUNETAS POLIGONAIS - INDUSTRIAL
Conteúdo: 6, 7, 8, 9, 10, 11, 12, 13, 14, 15, 16, 17, 18, 19, 20, 21, 22, 23, 24, 25, 26, 27, 28, 30, 32mm



FG 600/SC16

€/LISTA
~~232,00~~

PROMO
139,00€

JOGOS CHAVES DE BOCA/LUNETAS POLIGONAIS
Conteúdo: 6, 7, 8, 10, 12, 13, 14, 16, 17, 19, 21, 22, 24, 27, 30, 32mm

FG 600/SC25

€/LISTA
~~385,00~~

PROMO
219,00€

JOGOS CHAVES DE BOCA/LUNETAS POLIGONAIS
Conteúdo: 6, 7, 8, 9, 10, 11, 12, 13, 14, 15, 16, 17, 18, 19, 20, 21, 22, 23, 24, 25, 26, 27, 28, 30, 32mm



FG 600L/SC10

€/LISTA
~~162,00~~

PROMO
99,00€

JOGOS CHAVES DE BOCA/LUNETAS POLIGONAIS
Conteúdo: 10, 11, 12, 13, 14, 15, 16, 17, 18, 19mm



CHAVE POLIGONAL

da Fasano Tools é único e inovador: o cabo faz com que o beca poligonal fique encaixado entre si, de modo que o utilizador segure a chave de modo plano, tendo mais área de superfície.

isto permite que a força de aperto seja aumentada em mais de 20% em comparação com os interruptores comuns, reduzindo significativamente a tensão e a fadiga das mãos durante a utilização.



FG 600/TW

+ FORÇA DO TORQUE

FG 600TW/S12

€/LISTA
~~198,00~~

PROMO 119,00€

JOGO DE CHAVES POLIGONALES DE BOCA/LUNETA TWISTER
Conteúdo: 8, 9, 10, 11, 12, 13, 14, 15, 16, 17, 18, 19mm



FG 600XL/SC7

€/LISTA
~~260,00~~

PROMO 165,00€

JOGO DE CHAVES DE LUNETA DUPLAS DIREITAS, SÉRIE EXTRALONGA
Conteúdo: 8x10, 12x14, 13x15, 16x18, 17x19, 21x23, 22x24mm



FG 615/SC8

€/LISTA
~~116,00~~

PROMO 69,00€

JOGOS DE CHAVES DE LUNETA CON CURVADURA
Conteúdo: 6x7, 8x9, 10x11, 12x13, 14x15, 16x17, 18x19, 20x22mm



FG 602/SC13

€/LISTINO
~~150,00~~

PROMO 95,00€

JUEGO DE LLAVES FIJAS DE DOS BOCAS ABIERTAS
Contenido: 6x7, 8x9, 10x11, 12x13, 14x15, 16x17, 18x19, 20x22, 21x23, 24x26, 25x28, 27x29, 30x32mm



FG 180/SP9

€/LISTA
~~216,00~~

PROMO 129,00€

JOGOS CHAVES DE LUNETA ABERTA
Conteúdo: 8x10, 10x11, 11x13, 12x14, 17x19, 19x22, 24x27, 30x32mm



FG 600E/S4

€/LISTA
~~56,00~~

PROMO 33,90€

JOGO 4 CHAVES DIREITAS TORX
Conteúdo: E6xE8, E10xE12, E14xE18, E20xE24





CHAVES DE APERTO

FG 623H/S6

€/LISTA
~~149,00~~

PROMO
85,00€

JOGO DE CHAVES EM T HEXAGONAIS COM VEIO FIXO

Conteúdo: 2,5, 3, 4, 5, 6, 8mm

FG 623H/S8

€/LISTA
~~195,00~~

PROMO
119,00€

JOGO DE CHAVES EM T HEXAGONAIS COM VEIO FIXO

Conteúdo: 2, 2,5, 3, 4, 5, 6, 8, 10mm

FG 623H/S14

€/LISTA
~~395,00~~

PROMO
239,00€

JOGO DE CHAVES EM T HEXAGONAIS COM VEIO FIXO

Conteúdo: 2, 2,5, 3, 3,5, 4, 4,5, 5, 6, 7, 8, 9, 10, 12, 14mm



INDUSTRIAL

CHAVE T SEXTAVADA

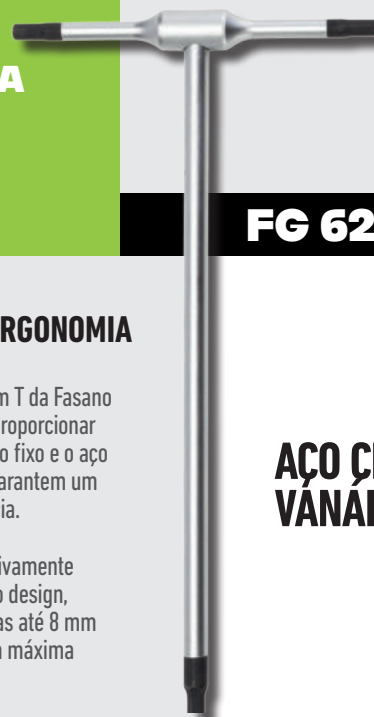

FG 623/H

DESEMPENHO E ERGONOMIA

A nova chave com cabo em T da Fasano Tools foi concebida para proporcionar um elevado binário. O cabo fixo e o aço especial Cromo Vanádio garantem um elevado nível de resistência.

A ergonomia foi significativamente melhorada graças ao novo design, enquanto as pontas polidas até 8 mm permitem trabalhar com a máxima precisão.

AÇO CROMO VANÁDIO

FG 621H/S8C

€/LISTA
~~162,00~~

PROMO
99,00€

JOGOS CHAVES EM T COM PONTAS

Conteúdo: 2, 2,5, 3, 4, 5, 6, 8, 10mm



FG 618/S7B

€/LISTA
~~265,00~~

PROMO
159,00€

JOGOS CAIXA HEXAGONAIS COM CARDAN E CABO EM T

Conteúdo: 7, 8, 10, 12, 13, 14, 17mm

FG 618/S7

€/LISTA
~~293,00~~

PROMO
179,00€

JOGOS CAIXA HEXAGONAIS COM CARDAN E CABO EM T

Conteúdo: 8, 10, 11, 13, 14, 17, 19mm

FG 618/S10

€/LISTA
~~418,00~~

PROMO
249,00€

JOGOS CAIXA HEXAGONAIS COM CARDAN E CABO EM T

Conteúdo: 8, 10, 11, 12, 13, 14, 15, 16, 17, 19mm

FG 621TX/S13

€/LISTA
~~250,00~~

PROMO
149,00€

JOGOS CHAVES EM T TORX COM PONTAS

Conteúdo: 6, 7, 8, 9, 10, 15, 20, 25, 27, 30, 40, 45, 50 TX



CHAVES PARA TUBOS MODELO FRONTAL



CÓDIGO	Ø GAS MAX	Ø MM MAX	L/MM	€/LISTA	€/PROMO
FG 30/GA1.5	1"1/2	33	250	40,00	24,00
FG 30/GA2	2"	42	300	48,00	29,00
FG 30/GA2B	2"	48	350	56,00	34,00
FG 30/GA2.5	2"1/2	60	450	82,00	49,00
FG 30/GA3	3"	73	600	125,00	75,00
FG 30/GA5	5"	102	900	150,00	90,00
FG 30/GA6	6"	141	1200	240,00	145,00

CHAVES PARA TUBOS MODELO SUECO COM MORDENTES A 45°



CÓDIGO	Ø GAS MAX	Ø MM MAX	L/MM	€/LISTA	€/PROMO
FG 32/GP1	1"	41	300	32,00	19,00
FG 32/GP1.5	1"1/2	56	420	45,00	27,00
FG 32/GP2	2"	68	530	70,00	42,00

FG 605/ST11-B

€/LISTA
~~238,00~~

PROMO
142,50€

JOGO DE CHAVES DE BOCA/LUNETA CON SISTEMA DE ROQUETE REVERSÍVEL
Conteúdo: 8, 9, 10, 11, 12, 13, 14, 15, 16, 17, 19mm



ANEL DE AÇO INTEGRADO PARA SEGURAR O PARAFUSO

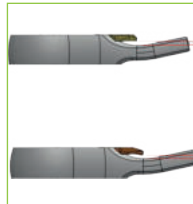

BANCO DE CORRIDA TRASEIRO COM PERNA ANGULAR POR BAIXO PARA MAIOR ESPAÇO DE MANUSEAMENTO

FG 615A/S6

€/LISTA
~~130,00~~

PROMO
75,00€

JOGO DE 6 CHAVES DE PORCAS DUPLAS COM ROQUETE UNIVERSAL REVERSÍVEL DE 90 DENTES
Conteúdo: 8x9, 10x11, 12x13, 14x15, 16x18, 17x19mm



CHAVES PARA TUBOS MODELO FRONTELEM EM ALUMINIO



CÓDIGO	Ø GAS MAX	Ø MM MAX	L/MM	€/LISTA	€/PROMO
FG 33/GA2	2"	48	350	60,00	36,00
FG 33/GA2.5	2"1/2	60	450	80,00	49,00
FG 33/GA3	3"	73	600	140,00	85,00
FG 33/GA5	5"	102	900	260,00	155,00
FG 33/GA6	6"	141	1200	310,00	189,00

CHAVES PARA TUBO MODELO LIGEIRO



CÓDIGO	Ø GAS MAX	Ø MM MAX	L/MM	€/LISTA	€/PROMO
FG 34/GL1	1"	38	175	25,00	14,90
FG 34/GL1.5	1"1/2	50	225	30,00	18,00
FG 34/GL2	2"	57	260	35,00	21,00
FG 34/GL2.5	2"1/2	70	300	40,00	24,00
FG 34/GL3	3"	50	225	45,00	27,00

FG 606/SP9

€/LISTA
~~145,00~~

PROMO
89,00€

JOGO DE CHAVES COMBINADAS NÃO REVERSÍVEIS
Conteúdo: 8, 10, 11, 12, 13, 14, 15, 17, 19mm



FG 610FL/SP9

€/LISTA
~~252,00~~

PROMO
149,00€

JOGO DE CHAVES COMBINADAS ESSÍVEL
Conteúdo: 8, 10, 12, 13, 15, 16, 17, 18, 19mm



FG 622A/S2

€/LISTA
~~80,00~~

PROMO
49,00€

JOGO DE CHAVES DE CATRACA UNIVERSAL 2 SÉRIES EXTRA LONGAS
Conteúdo: 21x22, 24x27 mm





CHAVES DE CAIXAS



23 mm
DE ESPACIO
TOTAL

NEW

FG 625/S15

€/LISTA

~~110,00~~

PROMO
69,00€

JOGO CHAVES DE CAIXA E ACESSÓRIOS

Com chaves de caixa planas e roquete de encaixe

Fornecido em caixa em ABS com revestimento interior em borracha macia

3/8"

CONTENTE



BÚSSOLAS PLANAS



L/mm 190



L/mm 75 - 3/8"



3/8"



8- 9- 10- 11- 12- 13- 14- 15- 16- 17- 18-19mm

QUALIDADE E FACILIDADE DE UTILIZAÇÃO

- Roquete com mecanismo de 72 dentes e cabo antiderrapante
- Inversión del sentido de giro con una sola mano gracias a la palanca especial y al mecanismo rápido de fijación/desmontaje de los accesorios con sistema de encaje a presión

ACESSIBILIDADE MÁXIMA

Permite alcançar até pontos de difícil acesso com o mínimo esforço, graças ao adaptador e à extensão incluídos

Design de cabeça de roquete ultrafina: apenas 11 mm de espessura



FG 624/S25

€/LISTA

~~98,00~~

PROMO
52,90€

JOGO 25 FERRAMENTAS COM ATAQUE DE 1/4"

1/4"



CONTENTE



FG 624/E

6,8,10,11,12,13mm



FG 624/CR14



FG 89/38PI1

1/4"x 1/4"



FG 85/25PH

1, 2, 3



FG 85/25PZ

1, 2, 3



FG 85/25F

4, 5, 6, 7



FG 85/25TX

10, 15, 20, 25, 27, 30, 40

FG 625/S110

€/LISTA
~~488,00~~

PROMO
269,00€

JOGO DE 110 FERRAMENTAS DE 1/4" E 1/2"



CONTENTE

	FG 625/A	8,9,10,11,12,13,14,15,16,17,18,19,20,21,22,23,24,25,26,27,30,32
	FG 624/E	4,5,6,7,8,9,10,11,12,13,14
	FG 624/CR14	
	FG 625/CR12	
	FG 625/SN12	
	FG 624/SN14	
	FG 625/ES12	
	FG 624/ES14	
	FG 624/GR14C	
	FG 625/PA	125, 250
	FG 624/PA	50, 100
	FG 89/38PI1	1/4"x1/4"
	FG 85/25PH	1,2,3
	FG 85/25SL	3,4,4,5,5,5,5,6,6,6,5
	FG 85/25PZ	1,2,3
	FG 85/H	1,5,2,2,5,3,4,5,6
	FG 85/25T	9,10,15,20,25,27,30,40
	FG 88/60P12	

	FG 139/B	
	FG 48/L	
	FG 49	
	FG 600/B	8,10,11,12,13,14,15,17,19
	FG 22	3x75, 4x100, 5.5x100
	FG 22/PH	0x60, PH1x80, PH2x100
	FG 59/XT160	
	FG 63/XT160	
	FG 58/B240	
	FG 132/H500	
	FG 79/SP	
	FG 93/M24	
	FG 44/MT5	



FG 625/S27

€/LISTA
~~196,00~~

PROMO
109,00€

JOGO DE 27 FERRAMENTAS DE 1/2"



CONTENTE

	FG 625/A	8,9,10,11,12,13,14,15,16,17,18,19,20,21,22,23,24,25,26,27,30,32
	FG 625/CR12	
	FG 625/SN12	
	FG 625/ES12	
	FG 625/PA	125,250



CHAVES DE CAIXA



CONTENTE

	FG 625/A	10,11,12,13,14,15,16,17,18,19,20,21, 22,23,24,27,30,32
	FG 624/E	4,4.5,5,5.5,6,7,8,9,10,11,12,13,14
	FG 625L/A	14,15,17,19,22
	FG 624E/L	6,7,8,9,10,11,12,13
	FG 625/TX	10,11,12,14,16,18,20,24
	FG 624/TX	4,5,6,7,8
	FG 181/B	16,21
	FG 624/CR14 FG 625/CR12	

FG BEST 108

€/LISTA
~~279,00~~

PROMO
159,00€

JOGO DE 108 FERRAMENTAS 1/4" Y 1/2"



	FG 625/SN12 FG 624/SN14	
	FG 625/ES12 FG 624/ES14	
	FG 624/GR14	
	FG 625/PR FG 624/PR	125 50,100
	FG 87/AD	
	FG 139/D	1,5,2,2,5
	FG 147/	PH (1,2), PZ (1,2), SL (4, 5.5, 6.5), H (4,5.5,6.5), TX (10,15,20,25,30)
	FG 85/	PH (3,4), PZ (3,4), SL (8,10,12), H (7,8,10,12,14), TX (40,45,50,55,60)



CONTENTE

	FG 625/A	10, 11, 12, 13, 14, 15, 16, 17, 18, 19, 20, 21, 22, 24, 27, 30, 32
	FG 624/E	4, 4.5, 5, 5.5, 6, 7, 8, 9, 10, 11, 12, 13, 14
	FG 624/B	10, 11, 12, 13, 14, 15, 16, 17, 18, 19
	FG 624/TX FG 624B/TX FG 625/TX	4, 5, 6, 7, 8, 10, 11, 12, 14, 16, 18, 20, 24
	FG 625L/A FG 624B/L FG 624E/L	16, 17, 18, 19, 22 10, 11, 12, 13, 14, 15 4, 5, 6, 7, 8, 9, 10
	FG 181/B FG 181/A	16, 21 18
	FG 87/AD FG 87/AD3	1/2"x5/16" 3/8"x5/16"
	FG 624/PR FG 624B/PR FG 625/PR	50, 100 125 125

FG BEST 171

€/LISTA
~~408,00~~

PROMO
199,00€

JOGO DE 171 FERRAMENTAS 1/4", 3/8" Y 1/2"



	FG 625/CR12 FG 624/CR38 FG 624/CR14	
	FG 624/GR14	
	FG 625/SN12 FG 624/SN38 FG 624/SN14	
	FG 625/ES12-B FG 624/ES14	
	FG 139/D	1, 1.5, 2, 2.5, 3, 4, 5
	FG 147/	PH (0, 1, 2), PZ (0, 1, 2), SL (4, 5.5, 6.5, 7), H (3, 4, 5), TX (8, 9, 10, 15, 20, 25, 27, 30), RTX (8, 9, 10, 15, 20, 25, 27, 30) PH (3, 4), PZ (3, 4), SL (8, 10, 12), H (7, 8, 10, 12, 14), TX (40, 45, 50, 55, 60, 70), RTX (40, 45, 50, 55, 60, 70) M (5, 6, 8), T (5, 6, 7), TT7, RIBE (5, 6, 7, 8, 9), TS (10, 15, 20, 25, 27, 30, 40, 45)
	FG 87/25	
	FG 85/25	

NEW



UMA GRANDE VARIEDADE, SEMPRE ORGANIZADA E AO SEU ALCANCE

77

CHAVES DE OPERAÇÃO

6

PERFIS TORX NOS TAMANHOS MAIS COMUNS

3

VÁRIOS ATAQUES 1/4", 3/8", 1/2"

PARA REALIZAR DIVERSOS PROCESSOS

Elevado desempenho e durabilidade ao longo do tempo: Ferramentas de elevada qualidade, fabricadas em aço cromo-vanádio.

Organização e praticidade: fornecidas num prático e resistente estojo com fecho metálico e marcações de tamanho e perfil para cada chave, para que estejam sempre organizadas e prontas a utilizar.

FG 625TX/S77

€/LISTA

~~295,00~~

PROMO
179,00€

JOGO DE 77 FERRAMENTAS TORX E TORX PLUS DE 1/4", 3/8", 1/2"

3/8"

1/4"

1/2"

CONTENTE



TX

1/4": TX6, 8, 10, 15, 20, 25, 27, 30
3/8": TX40, 45, 47, 50, 55
1/2": TX60, 70



TX CON FORO

1/4": T8H, 10, 15, 20, 25, 27, 30
3/8": T40H, 45, 50, 55
1/2": T60H



TX ESTERNO

1/4": E4, 5, 6, 7, 8
3/8": E10, 12, 14, 16
1/2": E18, 20, 22, 24



TX IP

1/4": 8IP, 10, 15, 20, 25, 27, 30
3/8": 40IP, 45, 50
1/2": 55IP, 60



TX IPR

1/4": 8IPR, 10, 15, 20, 25, 27, 30
3/8": 40IPR, 45, 50
1/2": 55IPR, 60



TX PLUS ESTERNO

1/4": EP4, 5, 6, 7, 8
3/8": EP10, 12, 14, 16
1/2": EP18, 20, 22, 24



FG 150TX/S32

€/LISTA

~~201,00~~

PROMO
125,00€

JOGO 32 CHAVES DE PONTA TORX 1/2"



CONTENTE



FG 150/TX

20 - 70



FG 150L/TX

20 - 70



FG 150XL/TX

40 - 70



FG 150XXL/TX

40 - 70



CHAVES DE CAIXA



FG 150M/S26

€/LISTA
~~185,50~~

PROMO
109,00€

JOGO 26 CHAVES DE PONTA XZN 1/2"



CONTENTE

	FG 150/M	5 - 16
	FG 150L/M	5 - 16
	FG 150XL/M	5 - 14
	FG 150XXL/M	8 - 14



FG 150H/S30

€/LISTA
~~200,00~~

PROMO
119,00€

JOGO 30 CHAVES DE PONTA HEXAGONAIS



CONTENTE

	FG 150/H	5 - 19
	FG 150L/H	5 - 13
	FG 150XL/H	5 - 14
	FG 150XXL/H	5 - 12



FG 629A/S15

€/LISTA
~~639,00~~

PROMO
339,00€

JOGO CAIXAS HEXAGONAIS 3/4"



CONTENTE

	FG 629/A	19,22,24,27,30,32,36,41,46,50,60mm
	FG 629/CR34	
	FG 629/SN34	
	FG 629/ES34	
	FG 629/PR200	



FG 629B/S15

€/LISTA
~~639,00~~

PROMO
339,00€

JOGO CAIXAS POLIGONAIS 3/4"



CONTENTE

	FG 629/B	19,22,23,27,30,32,36,41,46,50,60mm
	FG 629/CR34	
	FG 629/SN34	
	FG 629/ES34	
	FG 629/PR200	

FG 152/RTXS10

€/LISTA
~~179,00~~

PROMO
99,00€

JOGO DE 10 CHAVES DE PONTA TORX

Conteúdo:
RTX20, RTX25, RTX27, RTX30, RTX40, RTX45, RTX50, RTX55, RTX60, RTX70



FG 152RH/S9

€/LISTA
~~129,00~~

PROMO
69,00€

JOGO DE 9 CHAVES DE PONTA HEXAGONALES

Conteúdo:
RH5, RH6, RH7, RH8, RH10, RH12, RH14, RH17, RH19



FG 152RM/S9

€/LISTA
~~139,00~~

PROMO
69,00€

JOGO DE 9 CHAVES DE PONTA XZN - 1/2"

Conteúdo:
RM5, RM6, RM8, RM9, RM10, RM12, RM14, RM16, RM18



**CHAVE
BÚSSOLA
1/2"
HEXAGONAL
REFORÇADA**



EXTRA-PLANO

FG 629C/S10

€/LISTA
~~319,50~~

PROMO
179,00€

JOGO 10 CHAVES DE CAIXA DE IMPACTO HEXAGONAIS DA 3/4" EM CAIXA DE AÇO

Conteúdo: 17,19,22,24,27,30,32,36,41,46mm

3/4"



FG 630A/S14

€/LISTA
~~896,50~~

PROMO
499,00€

JOGO 14 CHAVES DE CAIXA DE IMPACTO HEXAGONAIS 1" EM CAIXA DE AÇO

Conteúdo: 24,27,30,32,33,34,36,38,41,46,50,55,60,65mm

1"



FG 628/S6

€/LISTA
~~98,00~~

PROMO
59,00€

JOGO 6 CHAVES DE CAIXA REFORÇADO 1/2" EM SUPORTE PLASTICO

Conteúdo: 22,23,24,27,30,32mm

1/2"



FG 628/S12

€/LISTA
~~134,00~~

PROMO
79,00€

JOGO 12 CHAVES DE CAIXA REFORÇADO 1/2" EM SUPORTE PLASTICO

Conteúdo: 10,11,12,13,14,15,16,17,18,19,20,21mm

1/2"





CHAVES DE FENDA E ALICATES



FG 22/S6

€/LISTA
~~37,00~~

PROMO
21,90€

JOGO DE CHAVES PARA PARAFUSOS DE PERFIL DE FENDA E PHILLIPS

Conteúdo: 3x75, 4x100, 5.5x100, PH0x60, PH1x80, PH2x100



FG 22/S8

€/LISTA
~~51,00~~

PROMO
27,90€

JOGO DE CHAVES PARA PARAFUSOS DE PERFIL DE FENDA E PHILLIPS

Conteúdo: 3x75, 4x100, 5.5x100, 6.5x30, PH0x60, PH1x80, PH2x100, PH2x30



FG 22/S8B

€/LISTA
~~60,00~~

PROMO
35,90€

JOGO DE CHAVES PARA PARAFUSOS DE PERFIL DE FENDA E PHILLIPS

Conteúdo: 2.5x75, 3.5x100, 4x100, 6.5x150, 8x150, PH0x60, PH1x80, PH2x150



FG 22/S12

€/LISTA
~~90,00~~

PROMO
49,90€

JOGO DE CHAVES PARA PARAFUSOS DE PERFIL DE FENDA E PHILLIPS

Conteúdo: 2.5x60, 3x75, 4x100, 5.5x150, 6.5x150, 8x150, 4x30, PH0x60, PH1x80, PH2x100, PH3x150, PH1x30



FG 22TX/S6

€/LISTA

~~70,00~~

PROMO
39,90€

JOGO CHAVES DE FENDA PARA PARAFUSOS DE PERFIL TORX

Conteúdo: TX10, TX15, TX20, TX25, TX27, TX30



FG 22RTX/S8

€/LISTA

~~94,50~~

PROMO
49,90€

JOGO CHAVES DE FENDA PARA PARAFUSOS DE PERFIL TAMPER RESISTANT TORX

Conteúdo: RTX10, RTX15, RTX20, RTX25, RTX27, RTX30, RTX40, RTX45



FG 22FX/S10

€/LISTA

~~147,00~~

PROMO
89,90€

JOGO CHAVES DE CAIXA COM HASTE RÍGIDA

Conteúdo 5, 5.5, 6, 7, 8, 9, 10, 11, 12, 13 mm



FG 139

€/LISTA

~~32,00~~

PROMO
22,90€

JOGO 12 CHAVES MACHOS HEXAGONAIS COM EXTREMIDADE ESFÉRICA - SÉRIE CORTA

Conteúdo: 1.5, 2, 2.5, 3, 4, 4.5, 5, 5.5, 6, 7, 8, 10 mm



FG 139/B

€/LISTA

~~16,50~~

PROMO
9,90€

JOGO 10 CHAVES MACHO HEXAGONAIS - SÉRIE CURTA

Conteúdo: 1.5, 2, 2.5, 3, 4, 5, 5.5, 6, 8, 10 mm



FG 139/L

€/LISTA

~~41,50~~

PROMO
24,90€

JOGO 12 CHAVES MACHOS HEXAGONAIS COM EXTREMIDADE ESFÉRICA - SÉRIE LONGA

Conteúdo: 1.5, 2, 2.5, 3, 4, 4.5, 5, 5.5, 6, 7, 8, 10 mm



FG 139/C

€/LISTA

~~24,50~~

PROMO
14,90€

JOGO 10 CHAVES MACHO HEXAGONAIS - SÉRIE LONGA

Conteúdo: 1.5, 2, 2.5, 3, 4, 5, 5.5, 6, 8, 10 mm



FG 142/S9

€/LISTA

~~128,00~~

PROMO
76,90€

JOGO 8 CHAVES MACHO HEXAGONAIS COM PUNHO BI-MATERIAL E EXTREMIDADE ESFÉRICA

Conteúdo: 2, 2.5, 3, 4, 5, 6, 7, 8, 10mm



FG 139/LM

€/LISTA

~~56,00~~

PROMO
33,90€

JOGO 10 CHAVES MACHO HEXAGONAIS

Conteúdo: 1.5, 2, 2.5, 3, 4, 5, 6, 7, 8, 10 mm



EXTREMIDADE MAGNÉTICA



CHAVES DE FENDA E ALICATES

FG 138/BP

€/LISTA
~~62,00~~

PROMO
36,90€

JOGO 9 CHAVES MACHO TORX COM EXTREMIDADE ESFÉRICA
Conteúdo: TX8, 10, 15, 20, 25, 27, 30, 40, 50



FG 138/B

€/LISTA
~~34,00~~

PROMO
19,90€

JOGO 10 CHAVES MACHO TORX
Conteúdo: TX9 - TX50 - SERIE CURTA



FG 138/M

€/LISTA
~~62,00~~

PROMO
37,90€

JOGO 10 CHAVES MACHO TORX
Conteúdo: TX10 - TX50



EXTREMIDADE MAGNÉTICA

FG 138/C

€/LISTA
~~37,00~~

PROMO
19,90€

JOGO 10 CHAVES MACHO TORX
Conteúdo: TX9 - TX50 - SERIE LONGA



FG 138

€/LISTA
~~55,00~~

PROMO
32,90€

JOGO 12 CHAVES MACHO TORX
Conteúdo: TX7, 8, 9, 10, 15, 20, 25, 27, 30, 40, 45, 50



FG 88/25-S31

€/LISTA
~~92,00~~

PROMO
59,00€

JOGO DE 30 PONTAS REFORÇADAS DE 1/4" E PORTA PONTAS MAGNÉTICO

Conteúdo: PH1, PH2, PH3 (x2);
PZ1, PZ2, PZ3;
SQ1, SQ2, SQ3;
T8, T9, T10, T15, T20, T25, T27, T30, T40;
H2, H3, H4, H5, H6, H8;
SL4, SL5.5, SL8

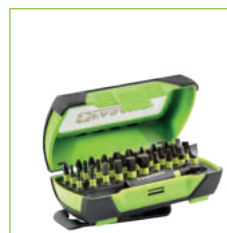

FG 143TX/S6

€/LISTA
~~82,00~~

PROMO
49,90€

JOGO 6 CHAVES MACHO DE PERFIL TORX COM PUNHO BI-MATERIAL
Conteúdo: TX10, TX15, TX20, TX25, TX30, TX40

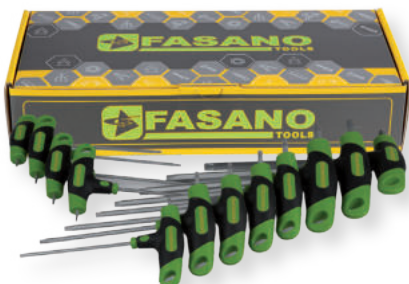

FG 85/175-S9

€/LISTA
~~106,00~~

PROMO
65,00€

JOGO DE 8 CHAVES DE FENDAS BIVALENTES E 1 PUNHO
Conteúdo: FG 85/175FPH0, PH1, PH2 (SL 4, 5.5, 6.5mm - PH 0, 1, 2)
- FG 85/175T6-8, T7-9, T10-15, T20-25, T30-40 - FG 85/IM



FG 85/175-S10

€/LISTA
~~115,00~~

PROMO
69,00€

JOGO DE 9 CHAVES DE FENDAS BIVALENTES E 1 PUNHO
Conteúdo: FG 85/175FPH0, PH1, PH2 (SL 4, 5.5, 6.5mm - PH 0, 1, 2)
- FG 85/175PZ1-2 - FG 85/175H2.5, H3,H4,H5,H6 - FG 85/IM



FG 59XT/S3

€/LISTA
~~89,50~~

PROMO
52,90€

JOGO 3 ALICATES INDUSTRIAL
Conteúdo: FG 59/XT180, FG 63/XT160, FG 61/XT160

FG 59XT/S3B

€/LISTA
~~99,50~~

PROMO
59,90€

JOGO 3 ALICATES INDUSTRIAL
Conteúdo: FG 63/H180, FG 61/XT200, FG 59/XT180



FG 58/C250

€/LISTA
~~44,00~~

PROMO
27,90€

ALICATE AJUSTÁVEL COM CHARNEIRA SOBREPOSTA E LIBERTAÇÃO RÁPIDA
mm - polegares: 250 - 10"
HRC: 54-58



SISTEMA DESLIZANTE INOVADOR SEM BOTÕES COM MECANISMO DE BLOQUEIO AUTOMÁTICO PARA SE ADAPTAR RAPIDAMENTE A DIFERENTES DIÂMETROS DE TUBULAÇÃO



FG 51/S4

€/LISTA
~~105,00~~

PROMO
64,90€

JOGO 4 ALICATES DE FREIOS 10-25MM
Conteúdo: FG 51/140, FG 52/140, FG 53/140, FG 54/140

FG 51/S4B

€/LISTA
~~112,00~~

PROMO
69,90€

JOGO 4 ALICATES DE FREIOS 19-60MM
Conteúdo: FG 51/180, FG 52/180, FG 53/180, FG 54/180

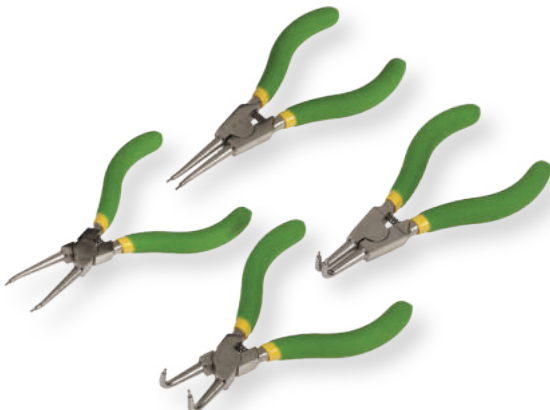

FG 55/S4

€/LISTA
~~140,00~~

PROMO
84,90€

JOGO DE 4 ALICATES DE FREIOS INTERIORES, COM PUNTAS REFORÇADAS DE AÇO 10-25MM
Conteúdo: FG 55/140, FG 56/140, FG 57/140, FG 58/140

FG 55/S4B

€/LISTA
~~145,00~~

PROMO
84,90€

JOGO DE 4 ALICATES DE FREIOS INTERIORES, COM PUNTAS REFORÇADAS DE AÇO 19-60MM
Conteúdo: FG 55/180, FG 56/180, FG 57/180, FG 58/180



INSERÇÕES REFORÇADAS PARA ANÉIS DE VEDAÇÃO GRANDES



ELETROTÉCNICA



FG 22E/S6

€/LISTA
~~60,00~~

PROMO
36,90€

JOGO 6 CHAVES PARA PARAFUSOS

Conteúdo: 3x100, 4x100, 5.5x125, PH0x60, PH1x80, PH2x100



1000V
IEC 60900

FG 22E/SZ6

€/LISTA
~~60,00~~

PROMO
36,90€

JOGO 6 CHAVES PARA PARAFUSOS

Conteúdo: 3x100, 4x100, 5.5x125, PZ0x60, PZ1x80, PZ2x100



1000V
IEC 60900



FG 68/SP

€/LISTA
~~36,00~~

PROMO
21,90€

ALICATE PARA CRAVAR TERMINAIS NÃO ISOLADOS

Ø/mm²: 0.2-6

AWG: 8-24

L/mm: 205



FG 68/SP2

€/LISTA
~~24,00~~

PROMO
14,90€

ALICATE FRONTAL DE DESCARNAR FIO

Ø/mm²: 0.2-6

AWG: 27-17

L/mm: 175



FG 68U/S439

€/LISTA
~~298,00~~

PROMO
179,00€

JOGO DE ALICATE COM MATRIZ INTERCAMBIÁVEL + 3 MATRIZ (FG 68/MAT4, FG 68/MAT16, FG 68/MAG), + 435 TERMINAIS ISOLADOS



FG 59IS/S3

€/LISTA
~~125,00~~

PROMO
69,90€

JOGO 3 ALICATEIS ISOLADAS

Conteúdo: FG 59/IS180, FG 61/IS200, FG 63/IS160



1000V
IEC 60900



FG 96/DG

€/LISTA
~~200,00~~

PROMO
119,00€



MULTÍMETRO DIGITAL DC/AC – OHM
Classe II
Categoria de sobretensão: CAT III 300V
Teste de continuidade
Frequência: 10Hz-200kHz
Teste de díodos
Ciclo de trabalho 5%-95% RH (± 0,1%)
Temperatura - 20°C/400°C (± 1,5% ± 3,0°C)
/ 400°C/1000°C (± 2,0% ± 3,0°C)
Medição de lux 4.000 lux (± 1) / 40.000 lux (± 10)
Capacidade de detecção de humidade 30%-90% HR (± 0,1%)
Capacidade de detecção de som 35 - 100dB (± 0,1dB)
Modo de espera após 15 minutos
Indicador do nível da pilha
Bateria de 9 V



DC	AC	Ω	LXPXH/MM
400mV-300V	4V-300V	400Ω-40MΩ	165x80x35

FG 98/DG

€/LISTA
~~350,00~~

PROMO
199,00€



MULTÍMETRO DIGITAL
Classe II
Categoria de sobretensão: CAT IV 600V;
CAT III 1000V
Frequência: 100 kHz
Frequência de amostragem 3 vezes por segundo
Capacidade de armazenamento de dados
Ecrã LCD
Teste de díodos
Luz LED para iluminar a área de trabalho
Base de suporte
Gancho de suspensão
Compartimento de arrumação na parte de trás
Desligamento automático após 15 minutos sem utilização
Pontas e sonda fornecidas
Fonte de alimentação: 1 pilha de 9V tipo 6F22



DC	AC	Ω	LXPXH/MM
6V-1000V	6V-750V	600Ω-60MΩ	184x90x46

FG 97/DG

€/LISTA
~~140,00~~

PROMO
79,00€



MULTÍMETRO DIGITAL SMART
Classe II
Categoria de sobretensão: CAT III 600V
Ensaio de díodos
Teste de continuidade
Tecnologia NCV
Capacidade de armazenamento de dados
Ecrã LCD
Luz LED na parte de trás para iluminar a área de trabalho
Tampa protetora amovível em borracha
Desligamento automático após 10 minutos sem utilização
Pontas incluídas
Fonte de alimentação: 1 pilha AAA de 1,5 V



DC	AC	Ω	LXPXH/MM
600mV-600V	6V-600V	600Ω-60MΩ	148x76x21

FG 99/DG

€/LISTA
~~260,00~~

PROMO
149,00€



PINÇA DE CORRENTE
Classe II
Categoria de sobretensão: CAT III 600V
Frequência de amostragem 3 vezes por segundo
Teste de díodos
Tecnologia NCV
Desligamento automático após 15 minutos sem utilização
Luz LED frontal para iluminar a área de trabalho
Ecrã LCD
Temperatura: -20°C a 1000°C (-4°F a 1832°F)
Frequência: 10Hz; 100Hz; 1000Hz; 10kHz; 100kHz; 1000kHz; 10MHz
Caixa, cabos de teste e sonda fornecidos
Fonte de alimentação: 3 pilhas de 1,5V TIPO AAA



DC	AC	Ω	LXPXH/MM
600mV-600V	6V-600V	600Ω-60MΩ	194x59x29



CHAVES DINAMOMÉTRICAS



PONTA PARA PARAFUSOS DE PERFIL TORX

Precisão $\pm 4\%$

Fornecido com certificado de calibração



CÓDIGO	RESOLUCIÓN NM	CONEXIÓN	NM	€/LISTA	€/PROMO
FG 531	0.1	1/4"	5-25	215,00	135,00
FG 533/2	0.25	3/8"	10-50	240,00	149,00
FG 536/1	0.5	1/2"	20-100	240,00	149,00
FG 536/2	1.0	1/2"	40-200	250,00	159,00
FG 536/3	2.0	1/2"	60-340	296,00	189,00

BARRA DINAMOMÉTRICA PARA APERTO À DIREITA E À ESQUERDA

Precisão $\pm 4\%$ - Fornecido em caixa ABS

Cabeça de roquete com libertação rápida

Punho ergonómico com anel de ajuste

Fornecido com certificado de calibração



CÓDIGO	RESOLUÇÃO NM	CONEXIÓN	NM	€/LISTA	€/PROMO
FG 540/1	2.5	3/4"	150-750	1.050,00	629,00
FG 540/2	2.5	3/4"	200-1000	1.200,00	739,00
FG 540/3	1.5	1"	200-1000	1.400,00	849,00

BARRA DINAMOMÉTRICAS PARA APERTO DIREITO E ESQUERDO - 3/4"

Precisão $\pm 4\%$.

Fornecido com certificado de calibração

Fornecido em caixa ABS



CÓDIGO	NM	CONEXIÓN CUADRADA	€/LISTA	€/PROMO
FG 538/1	140-560	3/4"	830,00	529,00
FG 538/2	200-800	3/4"	880,00	559,00
FG 539/1	200-1000	1"	1.150,00	699,00



CHAVES DINAMOMÉTRICAS DIGITAL DE ROQUETE REVERSÍVEL EM NM E GRAUS - 1/2"

1/2"

Precisão: ± 4%
Mão Direita e Esquerda
Duplo modo de medição: PEAK e TRACK
Som de 12 LED e indicador visual a realização do torque predeterminado
Possibilidade de memorizar até 250 rascunhos diferentes graças ao software para PC incluído no kit
Interface de PC via USB
Capacidade de configurar até 9 rascunhos pré-definidos
Fonte de alimentação: 2 baterias de 1,5V (incluídas)



CÓDIGO	NM	€/LISTA	€/PROMO
FG 543/DG1	6.8-135	715,00	429,00
FG 543/DG2	10-200	830,00	499,00



FG 546/DG

€/LISTA
~~330,00~~

PROMO
199,00€

1/2"

CHAVES DE APERTO ANGULAR DIGITAL EM NM E GRAUS

Precisão: ± 2%
Mão Direita e Esquerda
Duplo modo de medição: PEAK e TRACK
Som de 6 LED e indicador visual a realização do torque predeterminado
Possibilidade de memorizar até 50 rascunhos diferentes
Fonte de alimentação: 2 baterias de 1,5V (incluídas)



FG 547/DG

€/LISTA
~~210,00~~

PROMO
125,00€



CHAVES DE APERTO ANGULAR DIGITAL EM NM

Precisão: ± 2%
Mão Direita e Esquerda
Som de 6 LED e indicador visual a realização do torque predeterminado
Equipado com um suporte magnético

BARRA DINAMOMÉTRICAS

Precisão: ± 4%
Fornecido con informe de calibración



CÓDIGO	NM	RESOLUÇÃO	■ X □	L/MM	€/LISTINO	€/PROMO
FG 544/1	5-25	0.1	9x12	259	198,00	119,00
FG 544/2	10-50	0.25	9x12	385	216,00	129,00
FG 544/3	20-100	0.5	9x12	385	232,00	139,00
FG 544/4	40-200	1.0	14x18	480	280,00	169,00



MULTIPLICADOR DE BINÁRIO COM ACESSÓRIOS

CÓDIGO	■ X □	RELAÇÃO	NM	Ø/MM	€/LISTA	€/PROMO
FG 581/A	1/2" x 3/4"	1:6.5	231-1.500	80	950,00	559,00
FG 581/B	1/2" x 1"	1:12	208-2.500	80	1.320,00	789,00



FERRAMENTAS DE CORTE



FG 70/S110

€/LISTA
~~350,00~~

PROMO
199,00€

JOGO DE 110 MACHOS E CAÇONETOS EM AÇO AO CRÓMIO E ACESSÓRIOS
Roscas métricas de passo grosso e fino



						ACCESSÓRIOS
2x0.4	6x0.75	12x1	2x0.4	6x0.75	12x1	GF25x9
3x0.5	7x0.75	12x1.25	3x0.5	7x0.75	12x1.25	GF8x14
4x0.7	8x0.75	12x1.5	4x0.7	8x0.75	12x1.5	GMM1.5
5x0.8	8x1	14x1	5x0.8	8x1	14x1	GMM3
6x1	9x0.75	14x1.25	6x1	9x0.75	14x1.25	GMC1
7x1	9x1	14x1.5	7x1	9x1	14x1.5	
8x1.25	10x0.75	16x1	8x1.25	10x0.75	16x1	
9x1.25	10x1	16x1.5	9x1.25	10x1	16x1.5	
10x1.5	10x1.25	18x1.5	10x1.5	10x1.25	18x1.5	
11x1.5	11x0.75		11x1.5	11x0.75		
12x1.75	11x1		12x1.75	11x1		
14x2	11x1.25		14x2	11x1.25		
16x2	12x0.75		16x2	12x0.75		

FG 81HSS/S3

€/LISTINO
~~260,00~~

PROMO
165,00€

SET 3 FRESE CONICHE IN ACCIAIO HSS
4-12mm, 4-20mm, 4-30mm



FG 75CO/S25

€/LISTA
~~265,00~~

PROMO
159,00€

JOGO BROCAS RECTIFICADAS EM HSS-COBALT 5%
Conteúdo: 1-13x0,5mm



FG 49/L

€/LISTA
~~19,00~~

PROMO
11,90€

TESOURA COM LÂMINA EM AÇO INOXIDÁVEL
L/mm 200
Abertura máxima 151 mm
Lâmina de 87 mm
HRC: 54



FG 48/B

€/LISTA
~~25,00~~

PROMO
15,90

X-ACTO COM LÂMINA CURTA
L/mm: 110-180
Com 3 lâminas de substituição



FG 48/C

€/LISTA
~~9,60~~

PROMO
5,90

X-ACTO COM LÂMINA LONGA
L/mm: 154

NEW



FG 49/MU

€/LISTA
~~30,00~~

PROMO
18,90€

TESOURA COM LÂMINA DIREITAS EM AÇO INOXIDÁVEL, COM MICRO-DIENTES

Lâmina de 52mm



FG 48/P

€/LISTA
~~14,50~~

PROMO
8,90

CANETA MARCADORA
L/mm: 142
Com 3 lâminas de substituição



FG 49/TC

€/LISTA
~~46,00~~

PROMO
28,90€

TESOURA PARA ELECTRICISTA, COM ENTALHE PARA DESCARNAR CABO Y CORPO INTEIRAMENTE EM AÇO
L/mm 140 - Lâmina de 65mm
Lâmina de aço micro serrilhada
HRC: 56
Construção integral em aço inoxidável
Cortador de cabos 12mm
Com suporte para cinto



SUPOORTE DE CINTO



CONSTRUÇÃO TOTALMENTE EM AÇO FÔRJADO

FG 49/TCX

€/LISTA
~~62,00~~

PROMO
38,90€

TESOURA PARA ELECTRICISTA, COM ENTALHE PARA DESCARNAR CABO Y CORPO INTEIRAMENTE EM AÇO
L/mm 160 - Lâmina de 50mm
Lâmina de aço micro-serrilhada
HRC: 56
Estrutura integral de aço inoxidável
Cortador de cabo de 15 mm
Com suporte de correia



SUPOORTE DE CINTO



CONSTRUÇÃO TOTALMENTE EM AÇO FÔRJADO

FG 49/CF

€/LISTA
~~32,00~~

PROMO
17,90€

TESOURA PARA ELECTRICISTA COM FERRAMENTA DE ENGASTE PARA TERMINAIS DE TUBOS
L/mm 155 - Lâmina de 45mm
Lâmina de aço
HRC 52-54
Capacidade do cortador de cabos 12mm
Com entalhe para descarnar cabo e ferramenta de engaste para terminais de tubos



FERRAMENTA DE CRAVAÇÃO PARA TERMINAIS DE TUBO

FG 77/PVC4

€/LISTA
~~53,50~~

PROMO
33,90€

TESOURA COM ROQUETE
Sistema de cremalheira com avanço progressivo
Equipada com plataforma de nylon para facilitar o corte de perfis planos
Para tubos de PVC
Ømm: 0-42





MANUTENÇÃO GERAL



FITAS MÉTRICAS. REVESTIMENTO ABS DE 2 COMPONENTES RESISTENTE AO CHOQUE, FITA EM AÇO
Classe II



CÓDIGO	L/MT	BANDA MM	€/LISTA	€/PROMO
FG 44/MT3	3	16	11,50	6,90€
FG 44/MT5	5	25	20,50	12,90€
FG 44/MT8	8	25	25,50	15,90€
FG 44/MT10	10	25	30,00	18,90€

FG 95/DG

€/LISTA
~~96,00~~

PROMO
57,90€

PAQUÍMETRO DIGITAL LEITURA CENTESIMAL
L/mm: 150

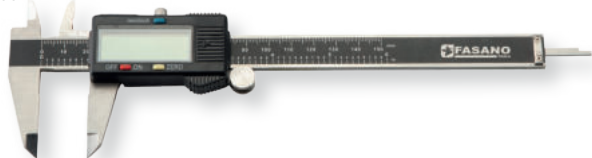

FG 95/CA

€/LISTA
~~52,00~~

PROMO
29,90€

PAQUÍMETRO LEITURA CINQUAGESIMAL

Escada cromada
Haste fina
Fecho de parafuso
Aço inoxidável endurecido
L/mm: 150

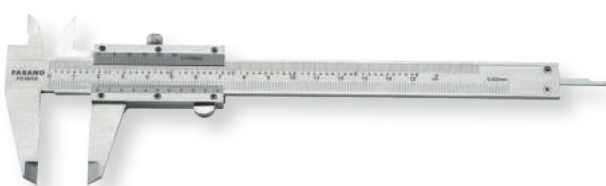

FG 128/S11

€/LISTA
~~122,00~~

PROMO
72,90€

JOGO 11 FERRAMENTAS DE PERCUSSÃO COM PUNHO
Conteúdo: FG 128/SC12, FG 128/SC16, FG 128/PU2, FG 128/PU10



FG 128C/S6

€/LISTA
~~48,00~~

PROMO
28,90€

JOGO DE 6 SACA-TROÇOS
Medições: 2, 3, 4, 5, 6, 8mm



FG 47/S3

€/LISTA

~~61,00~~

PROMO
36,90€

JOGO DE 3 RASPADORES COM LÂMINA DE AÇO INOXIDÁVEL

Lâmina em aço inoxidável

Cabo equipado com cabeça de aço para utilização em pancadas

Cabo em polipropileno com revestimento de borracha antiderrapante
Equipado com orifício para pendurar



FG 125/S3

€/LISTA

~~70,00~~

PROMO
43,90€

JOGO DE 3 ALAVANCAS DE IMPACTO

Conteúdo: 300, 450, 600 mm



FG 126/S3

€/LISTA

~~36,00~~

PROMO
22,90€

JOGO DE 3 MINI MANETES COM PONTAS ANGULARES

O ângulo de inclinação de 25° permite o acesso mesmo nos locais mais difíceis

Extremo a golpear em la palanca Ø/mm 6



NEW



FG 93/M50

€/LISTA

~~31,00~~

PROMO
18,90€

ESPELHO DE AÇO TELESCÓPICO E ARTICULADO

Ø/mm espelho 50

L/mm haste 240-698



FG 93/M95

€/LISTA

~~31,00~~

PROMO
18,90€

ESPELHO DE AÇO TELESCÓPICO E ARTICULADO

Dimensões do espelho mm 50x95

L/mm haste 370-775



FG 92/GR

€/LISTA

~~28,00~~

PROMO
16,90€

EXTENSÃO MAGNÉTICA FLEXÍVEL

Capacidade 1 kg

L/mm 700

Equipado com mandíbulas de preensão

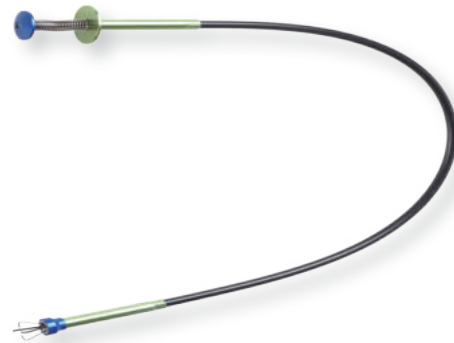

MÃOS PREËNSEIS

FG 92/PM

€/LISTA

~~21,00~~

PROMO
12,90€

EXTENSÃO MAGNÉTICA FLEXÍVEL

Haste de 1 metro

Pega de borracha antiderrapante



FG 92/PF

€/LISTA

~~27,50~~

PROMO
15,90€

EXTENSÃO MAGNÉTICA ARTICULADA

Capacidade 3,5 kg

L/mm haste 400

Ø/mm 1,5

Ponta magnética



FG 92/PM4

€/LISTA

~~27,50~~

PROMO
14,90€

EXTENSÃO MAGNÉTICA TELESCÓPICA

L/mm 165-622

Pega em PVC antiderrapante

Capacidade 2.3kg





FG 98/GAS

€/LISTA
~~149,00~~

PROMO
85,00€

SOLDADOR A GÁS PORTÁTIL

Temperatura máxima: 210-450 °C

25 watts

Autonomia 120 minutos

Fornecido com pontas para soldar, cortar e soprar

Fornecido em caixa ABS



FG 98/LT

€/LISTA
~~188,00~~

PROMO
119,00€

FERRO DE SOLDAR RECARREGÁVEL COM BATERIAS DE LÍTIU

Temperatura máxima: 600 °C

Autonomia 40 minutos

Tempo de carregamento 3,5h

Fornecido com pontas para soldar, cortar e soprar

Fornecido em caixa ABS

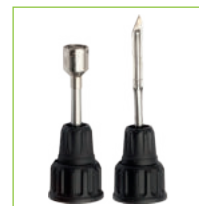

FG 96/SS36

€/LISTA
~~65,00~~

PROMO
39,90€

SOLDADOR DE PALHETAS DE DUPLA POTÊNCIA

Classe de proteção I

30/60 Watt - 230V - Ø/mm 5.8



FG 494/S12

€/LISTA
~~55,00~~

PROMO
34,90€

PISTOLA DE COLA QUENTE

Potência de aquecimento nominal 80W

Temperatura de funcionamento: 193°C (383 °F)

Tempo de aquecimento: 3/5 minutos

Comprimento do bastão de cola: 200mm

Diâmetro do bastão de cola: 11,5 mm

Fornecido em caixa ABS com 12 bastões de cola incluídos



FG 493/AL

€/LISTA
~~47,00~~

PROMO
29,90€

PISTOLA DE SELANTE COM TUBO DE ALUMÍNIO

L/mm 240

Equipado com sistema anti-gotejamento

Capacidade 300cc



FG 493/N

€/LISTA
~~39,00~~

PROMO
23,90€

PISTOLA DE SELAGEM COM TUBO DE AÇO

Corpo principal e mecanismo interno totalmente em aço

Capacidade 300cc



FG 494/A180

€/LISTA
~~190,00~~

PROMO
119,00€

PISTOLA DE COLA QUENTE

Potência nominal de aquecimento 180W

Equipado com um pé de apoio para evitar que a ponta aquecida toque na superfície da bancada

Temperatura de funcionamento 193°C

Tempo de aquecimento 3/5 minutos

L/mm stick cola 100/250/350

Stick cola Ø/mm 11/11,5

Fornecido com 1 bocal de substituição



FG 113/A

€/LISTA
~~215,00~~

PROMO
129,00€

CAIXA DE FERRAMENTAS DE CHAPA METÁLICA

Equipado com pegas laterais rebatíveis
Predisposição para cadeado
Estrutura em chapa de aço 0,8 mm
Dimensões 520x290x290 mm



FG 113/B

€/LISTA
~~248,00~~

PROMO
139,00€

CAIXA DE FERRAMENTAS DE CHAPA METÁLICA

Equipado com pegas laterais rebatíveis
Predisposição para cadeado
Estrutura em chapa de aço 0,8 mm
Dimensões 650x350x350 mm



FG 113/C

€/LISTA
~~260,00~~

PROMO
149,00€

CAIXA DE FERRAMENTAS DE CHAPA METÁLICA

Equipado com pegas laterais rebatíveis
Predisposição para cadeado
Estrutura em chapa de aço 0,8 mm
Dimensões 850x350x350 mm



FG 113/D

€/LISTA
~~335,00~~

PROMO
199,00€

CAIXA DE FERRAMENTAS DE CHAPA METÁLICA

Equipado com pegas laterais rebatíveis
Predisposição para cadeado
Estrutura em chapa de aço 0,8 mm
Dimensões 1000x400x450 mm



FG 111/AS104

€/LISTA
~~863,50~~

PROMO
359,00€

CAIXA EXTENSÍVEL COM 5 DIVISÕES E SORTIDO DE 104 FERRAMENTAS



FG 111/A

€/LISTA
~~62,00~~

PROMO
32,90

CAIXA EXTENSÍVEL COM 3 DIVISÕES EM CHAPA METÁLICA

Previsão para cadeado
Divisória do compartimento superior
Estrutura em chapa metálica
Dimensões 430x200x160 mm



CAIXA EXTENSÍVEL COM 5 DIVISÕES EM CHAPA METÁLICA

Previsão para cadeado
Divisória do compartimento superior
Estrutura em chapa metálica

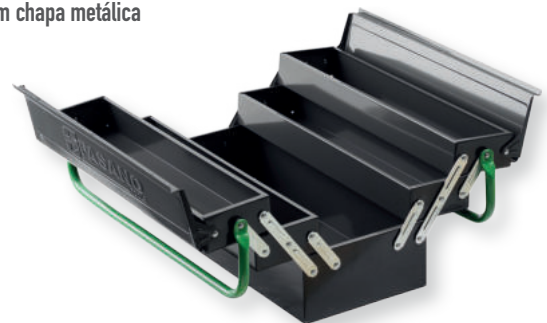

CÓDIGO	DIMENSÕES MM	€/LISTA	€/PROMO
FG 111/B	430x200x200	75,00	39,90
FG 111/C	530x200x200	94,00	49,90



FG 1450

€/LISTA
~~142,00~~

PROMO
84,90€

SACO DE FERRAMENTAS EM TECIDO 600D

Tecido técnico de alta resistência
Base semi-rígida com rebordos de plástico
Grande compartimento central
Vários bolsos interiores e exteriores
Bolso traseiro fechado e bolso frontal duplo fechado com presilhas
Alça de ombro almofadada ajustável



BASE SEMIRRÍGIDA



BOLSO FECHADO NA PARTE DE TRÁS



FG 1456

€/LISTA
~~270,00~~

PROMO
159,00€

CARRINHO DE FERRAMENTAS EM TECIDO 600D

Tecido técnico de alta resistência
Pega telescópica e 2 rodas robustas para um transporte fácil
Construção rígida com grande compartimento interior para guardar ferramentas eléctricas, ferramentas manuais e acessórios
Bolsos interiores e exteriores para uma organização óptima do espaço
2 bolsos exteriores fechados à frente



COMPARTIMENTO INTERNO AMPLO

TECIDO TÉCNICO DE ALTA RESISTÊNCIA

FG 1452

€/LISTA
~~165,00~~

PROMO
99,00€

SACO DE FERRAMENTAS EM TECIDO 600D COM TAMPA

Estrutura rígida em tecido técnico de alta resistência
Base de plástico rígido para proteção do conteúdo
Grande compartimento aberto para um acesso fácil ao conteúdo
Tampa com fecho de velcro
Pega metálica com punho de borracha macia
Vários bolsos e presilhas interiores e exteriores
Bolso lateral fechado e bolso frontal para serra
Alça de ombro almofadada ajustável



DIVERSAS BOLSAS



GRANDE COMPARTIMENTO CENTRAL ABERTO



FG 1460

€/LISTA
~~165,00~~

PROMO
99,00€

MOCHILA PARA FERRAMENTAS EM TECIDO 600D

Tecido técnico de alta resistência
Base de plástico rígido para proteção do conteúdo
Compartimento interno duplo, compartimento para ferramentas e compartimento para computador portátil e documentos
Vários bolsos laterais e frontais, interiores e exteriores
Encosto ergonómico almofadado
Alças acolchoadas para os ombros e alça ajustável para o peito



COMPARTIMENTO INTERNO DUPLA COM SUPORTE PARA PC

ALÇAS DE OMBRO ACOLCHOADAS



FG 1454

€/LISTA
~~215,00~~

PROMO
129,00€

SACO DE FERRAMENTAS EM TECIDO 600D

Estrutura rígida em tecido técnico de alta resistência
Base de plástico rígido para proteção do conteúdo
Dois grandes compartimentos separados
Vários bolsos e presilhas interiores e exteriores
Bolsos fechados nas costas e na frente
Pega confortável e alça de ombro almofadada ajustável



VÁRIOS BOLSOS INTERNOS



BOLSO FECHADO NA PARTE DE TRÁS



FG 1465

€/LISTA
~~200,00~~

PROMO
119,00€

MOCHILA PARA FERRAMENTAS EM TECIDO 600D COM RODAS

Dimensões da bagagem de mão
Tecido técnico de alta resistência
Pega telescópica retrátil
Rodas integradas com tampa rebatível
Compartimento interior duplo, compartimento para ferramentas e compartimento para computador portátil e documentos
Vários bolsos laterais e frontais, interiores e exteriores
Encosto ergonómico almofadado
Alças de ombro almofadadas e alça peitoral ajustável e bloqueável



DIMENSÕES BAGAGEM DE MÃO

COMPARTIMENTO INTERNO DUPLA



CAIXA DE FERRAMENTAS EM ABS

Pega retrátil para um transporte fácil
Sistema de fecho reforçado
Suporte de etiquetas
Predisposição para cadeado
Dimensões: 456 x 372 x 115 mm - Peso: 2,1 kg



EMPLHÁVEL



DISPOSITIVO PARA DATA ENCADEADA

CÓDIGO	DIMENSÕES mm	€/LISTA	€/PROMO
FG 1425	456x372x115	102,00	61,90
FG 1426	456x372x155	120,00	71,90
FG 1427	456x372x262	170,00	99,00

FG 1434

€/LISTA
~~145,00~~

PROMO
86,90€

CAIXA DE FERRAMENTAS COM DE CAIXAS INTERNAS EM ABS

Pega retrátil para um transporte fácil
Sistema de fecho reforçado
Suporte de etiquetas
Predisposição para cadeado
Dimensões: 456 x 372 x 115 mm - Peso: 3,2kg



FG 109/L3

CARRINHO DE OBJETOS DOBRÁVEL

Sistema de bloqueio
Dimensões: 945 x 485 x 810 mm
Peso: 11 kg
Capacidade de carga: 300 kg



€/LISTA
~~289,00~~

PROMO
169,00€

FG 1433

CARRO DE FERRAMENTAS TIPO TROLLEY REBATÍVEL

Rodas Ø 180 mm
Estrutura em ferro - base em alumínio
Peso 6kg - Capacidade 100kg



DIMENSÕES FECHADO: 835x485x70mm



Base 480x350mm

€/LISTA
~~198,00~~

PROMO
119,00€

FG 1445

CAIXA DE PEÇAS PEQUENAS EQUIPADA DE 8 BOXES REMOVÍVEIS E DIVISÓRIAS AJUSTÁVEIS

Dimensões mm 385x320x60



€/LISTA
~~50,00~~

PROMO
29,90€

FG 1440

CAIXA DE PEÇAS PEQUENAS EQUIPADA DE 12 BOXES REMOVÍVEIS

Dimensões mm 400x400x70



€/LISTA
~~60,00~~

PROMO
35,90€

ILUMINAÇÃO



FG 202

€/LISTA

~~56,00~~

PROMO
34,90€

LÂMPADA RECARREGÁVEL DE LED COM SISTEMA TSC

LED apontador superior
TSC SYSTEM, tecnologia de desligamento automático em contacto com superfícies
Corpo em alumínio anodizado
Ímã duplo, na base e no verso
Gancho para cinto
Cabo USB tipo C incluído
Dimensões 46x115 mm

MAX 1200 LUMEN



115mm



GANCHO DE CINTO



LED APONTADOR SUPERIOR



TECNOLOGIA DE DESLIGAMENTO POR TOQUE

FG 204

€/LISTA

~~32,50~~

PROMO
19,90€

MINI LÂMPADA LED PORTÁTIL

Clipe para cinto
Cabo USB Tipo C incluído
Dimensões: 21 x 89 mm
Clip para cinturón
Cable USB tipo C incluído
Dimensiones: 21 x 89 mm



MAX 300 LUMEN

89mm



BASE MAGNÉTICA



DESIGN COMPACTO

FG 203

€/LISTA

~~22,00~~

PROMO
12,90€

MINI PROJETOR PORTÁTIL LED

Equipado com ímãs traseiros e duas portas de carregamento
Cabo de carregamento USB Tipo C incluído
Corpo em alumínio anodizado
Função de regulação de brilho
Dimensões: 28,4 x 32 mm

MAX 100 LUMEN



28,4mm

32mm



BASE MAGNÉTICA



DUAS PORTAS DE CARREGAMENTO USB TYPE-C E MICRO USB

FG 214/L600

€/LISTA

~~85,00~~

PROMO
42,90€

TOCHA LED RECARREGÁVEL

Cone de luz ajustável
Indicador do estado de carregamento
Base de carregamento com suporte de parede e cabo USB incluídos



MAX 600 LUMEN



135mm



CONE DE LUZ AJUSTÁVEL



PLACA DE MONTAGEM NA PAREDE INCLUÍDA

FG 211

€/LISTA
~~119,00~~

PROMO
59,90€

LÂMPADA LED RECARREGÁVEL

Led de ponta superior
Regulador de luminosidade
Rotação de 360
Corpo fino em polipropileno com inserções de borracha antiderrapante
5 níveis de indicação da duração restante da bateria
Base magnética com gancho amovível e ajustável em 9 posições
Classificação IP54 de resistência à água e ao pó
Carregador de pilhas incluído



MAX 600 LUMEN



LED A APONTAR PARA CIMA



ROTAÇÃO DE 360

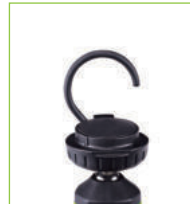

BASE MAGNÉTICA Y GANCHO DESMONTABLE

FG 207

€/LISTA
~~65,00~~

PROMO
38,90€

LÂMPADA LED RECARREGÁVEL

Led de ponta superior
180° pivotante
Base magnética
Indicador do estado de carga
Classificação IP54 de resistência à água e ao pó
Cabo USB tipo C incluído
H/mm 300



MAX 300 LUMEN

CE

300mm



LED A APONTAR PARA CIMA



ROTAÇÃO E PIVÔ DE 180°

FG 207/B

€/LISTA
~~92,00~~

PROMO
59,90€

LÂMPADA LED RECARREGÁVEL

Led de topo
Pivotante e rotativo a 180
3 níveis de indicação de autonomia restante
Base magnética
Gancho amovível integrado na base
Grau de resistência à água e ao pó IP54
Grau de resistência ao impacto IK07
Cabo USB tipo C incluído
H/mm 400



MAX 700 LUMEN

CE

400mm



GIRATORIO ROTAÇÃO ATÉ 180°



ROTAÇÃO ATÉ 180°



SELETOR DE BRILHO
60-700 LUMEN

FG 212

€/LISTA
~~78,00~~

PROMO
43,90€

LÂMPADA LED RECARREGÁVEL

Led de ponta superior
Giratório 360
Base magnética
Grau de proteção IP20
Cabo USB tipo C incluído



MAX 200 LUMEN

CE

174mm



LED A APONTAR PARA CIMA



ROTAÇÃO DE 360

FG 213/B

€/LISTA
~~149,00~~

PROMO
89,00€

MAX 1000 LUMEN

MAX 10h 3h T



LÂMPADA RECARREGÁVEL COM LED DUPLO
LED duales de 600/300 lúmenes en la parte frontal y trasera, y un LED de enfoque superior de 120 lúmenes
Modo de iluminación completa con tres LED encendidos para una iluminación máxima del espacio de trabajo con 1000 lúmenes
Gancho giratorio extraíble en la base
Imán en la parte trasera y en la base de la lámpara.
Giro de 180°
3 LED para indicar el estado de carga
Base de carga magnética con cable USB tipo C incluido
Dimensiones: 51,5 x 42,5 x 343 mm

NEW

343mm



BASE DE CARREGAMENTO INDUTIVO



PIVÔ DE 180°



BRILHO MÁXIMO DE 1000 LÚMENS

FG 201

€/LISTA
~~50,00~~

PROMO
29,90€

MAX 100 LUMEN

MAX 6h 2.5h T



LANTERNA MAGNÉTICA RECARREGÁVEL PARA TELESCÓPIO
Haste telescópica extensível até 505 mm
Indicador LED de estado de carregamento
no botão de alimentação
Gancho lateral
Cabo USB tipo C incluído
Dimensões: 21 x 18 x 178 mm

178mm

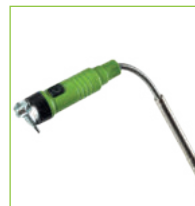

FUNÇÃO DE CAPTAÇÃO (CAPACIDADE DE CARGA MAGNÉTICA DE 1.2 KG)



GANCHO DE CINTO



VARA TELESCÓPICA EXTENSÍVEL ATÉ 505 mm

FG 213/L480

€/LISTA
~~65,00~~

PROMO
39,90€

MAX 500 LUMEN

MAX 10h 2.5h T



LÂMPADA DUPLA LED COM SENSOR ON/OFF SEM CONTATO
Con sensor de encendido/apagado sin contacto
4 niveles de inclinación
Indicador de estado de carga
4 imanes traseros para usar sin la banda elástica
Dimensiones: 68 x 39 mm
Com sensor de ligar/desligar sem contacto
4 níveis de inclinação
Indicador de estado de carregamento
4 ímanes traseiros para utilização sem a faixa elástica
Bateria removível e compatível com 3 pilhas AAA
Cabo USB Tipo C incluído



FG 206

€/LISTA
~~56,00~~

PROMO
33,90€

MAX 360 LUMEN

MAX 3h 4.5h T



LÂMPADA LED RECARREGÁVEL
Design fino
Ímanes na parte de trás
Gancho para pendurar a lâmpada
Grau de proteção IPX4
Cabo micro USB incluído
Dimensões 10x249

249mm



GANCHO SUPERIOR



EXTRA PLANO

FG 205/C

€/LISTA
~~149,00~~

PROMO
79,00€

MAX 1000 LUMEN

LÂMPADA LED RECARREGÁVEL

LED superior com brilho de 60 lúmens
2 portas retraíveis a 360° no lado traseiro
2 ímanes traseiros + 1 íman na base giratória
4 LEDs indicadores do estado
Cabo USB tipo C incluído
Função de power bank (saída máxima USB 5V 1A)
Função dimmer
Dimensões: 66x39x310

NEW

MAX 12h

4.5h

CE

310mm



1 BASE GIRATORIA DE 180°



LED DE TETO DE 60 LÚMENS



2 GANCHOS AMOVÍVEIS QUE GIRAM 360°

FG 205/B

€/LISTA
~~85,00~~

PROMO
49,90€

MAX 600 LUMEN

LÂMPADA LED PORTÁTIL

Luz LED superior com 200 lúmens de brilho
Gancho giratório amovível na parte traseira
Base giratória de 180° com íman integrado
4 LEDs indicadores de estado de carregamento
Cabo USB Tipo C incluído
Dimensões: 54 x 32 x 186"

186mm



UM DATADOR COM ROTAÇÃO DE 360°



BASE GIRATORIA DE 180° COM ÍMAN INTEGRADO

FG 217/B

€/LISTA
~~309,00~~

PROMO
179,00€

MAX 6000 LUMEN

LÂMPADA RECARREGÁVEL COM 3 LUZES LED

Também pode ser utilizado ligado ao carregador com um brilho de 500 lm
Potente bateria de lítio de 7,3 V - 8000 mAh
3 luzes LED pivotantes (180°) e giratórias (270°)
4 indicadores LED de estado de carga
Função de power bank de 5 V 1 A
Base magnética com gancho removível integrado
Altura total de 1700 mm (incluindo a lâmpada)
Bolsa em nylon incluída
Cabo USB Tipo C incluído
Dimensões: 90 x 90 x 205"

CE

MAX 8h

10h



3 ÍMANES NA BASE



LÂMPADAS GIRATÓRIAS ATÉ 270

205mm



TRIPÉ TELESCÓPICO ATÉ 1,70 M



FG 210/C

€/LISTA
~~165,00~~

PROMO
99,00€

MAX 3000 LUMEN

MAX 25h 6h IP 65

REFLETOR DE TRABALHO DE LED RECARREGÁVEL

Função de banco de potência (saída USB máxima 5V 2A)
Suporte giratório de 180°
5 níveis de indicação da autonomia restante
Classificação IP65 de resistência à água e ao pó
Grau de resistência ao impacto IK07
Índice de restituição de cor CRI 70+
Cabo USB tipo C incluído
Dimensões 208x140 mm



SUPOORTE GIRATÓRIO DE 180°



FUNÇÃO DE BANCO DE POTÊNCIA

FG 222/A

€/LISTA
~~80,00~~

PROMO
49,00€

MAX 500 LUMEN

MAX 15h 4,5h IP 54

LÂMPADA DE LED RECARREGÁVEL COM ALTO-FALANTES SEM FIO

Led apontador superior
Altifalante duplo sem fios de 5 W
Gancho com ímãs integrados, amovível e giratório a 180° para pendurar ou apoiar o candeeiro
Classificação IP54 de resistência à água e ao pó
Cabo USB tipo C incluído
Dimensões 65x164 mm



FOCO LED COM MAIS DE 160 LÚMENS



ALTAVOZ INALÁMBRICO DUAL 5W



GANCHO AMOVÍVEL QUE PODE SER RODADO ATÉ 180°

FG 210/W

€/LISTA
~~75,00~~

PROMO
47,90€

MAX 670 LUMEN

PROJETOR LED PORTÁTIL

Foco rotativo de 210° com íman integrado
Reflector de 250 lúmens
Recarregável de duas formas:
- com o cabo USB Tipo C incluído em 4 horas;
- sem fios em 6 horas
3 LEDs indicadores de carga
Dimensões: 83 x 35 x 100 mm



BASE MAGNÉTICA



FOCO/FOCO DIFUSO



LÂMPADA ORIENTÁVEL 210°

MAX 10h 4h

FG 222/B

€/LISTA
~~290,00~~

PROMO
169,00€

MAX 4000 LUMEN

MAX 15h 3h

LUZ DE TRABALHO DE LED RECARREGÁVEL COM ALTO-FALANTES SEM FIO

Altifalante duplo sem fios de 10 W
Função de banco de potência (saída USB máxima 5V 1A)
Corpo giratório de 140°
5 níveis de indicação da duração restante da bateria
Gancho amovível e giratório integrado na base
Classificação IP65 de resistência à água e ao pó
Carregador de bateria incluído
Dimensões 210x210 mm



GANCHO AMOVÍVEL E INTEGRADO



ALTAVOCES INALÁMBRICOS DE 10 W



CORPO GIRATÓRIO DE 140°

FG 221

€/LISTA
~~260,00~~

PROMO
159,00€

MAX 4500 LUMEN

LUZ DE TRABAJO DE DOBLE CABEZAL

Rotação horizontal de 180° por luminária: ilumina eficazmente diferentes áreas do ambiente de trabalho
Corpo giratório de 90°
Bateria de lítio amovível de 14,8 V com função Power Bank (saída USB máx. 5 V 2 A)
5 níveis de indicação da vida útil restante da bateria
Carregador de bateria incluído
Dimensões 190x295 mm



MAX 12h 4,5h



BATERIA DE LÍLIO COM FUNÇÃO DE POWER BANK



BATERIA EXTRAÍVEL



CORPOS ILUMINANTES REGULÁVEIS ATÉ 180°

FG 224/L5200

€/LISTA
~~229,00~~

PROMO
139,00€

LUZ LED RECARGABLE PARA OBRA CON LENTE ANTIDESLUMBRANTE

Lente opaca especial que reduz o encandeamento e aumenta a difusão da luz
Suporte giratório de 180° que pode ser ligado a um tripé
3 níveis de indicação da vida útil restante da bateria
Classificação IP65 de resistência à água e ao pó
Grau de resistência ao impacto IK07
Carregador de bateria incluído
Dimensões 273x205 mm



MAX 5200 LUMEN



MAX 15h
4h



ROTATIVO 180°

GRADO DE PROTECCIÓN IP65

FG 224/SU

TRIPÉ DE LUZ DE CONSTRUÇÃO FG 224/L5200

Altura máxima 1,60 M

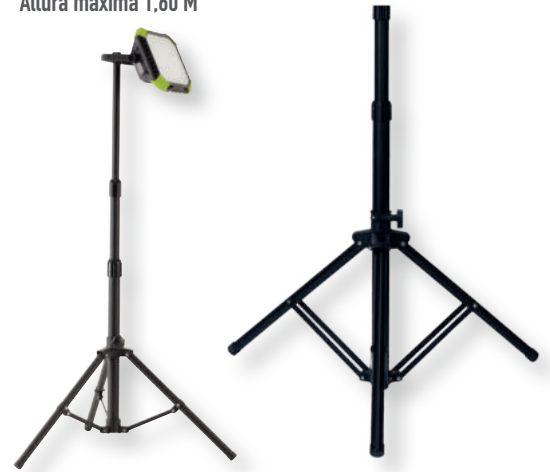

€/LISTA
~~80,00~~

PROMO
49,00€

FG 209

€/LISTA
~~265,00~~

PROMO
149,00€

LÂMPADA RECARREGÁVEL LED COM LENTE TRANSPARENTE E SEMITRANSARENTE

Comprimento ajustável até 2150 mm
Rotação de 360°
Função de regulação da intensidade da luz
3 tipos de lentes disponíveis
4 níveis de indicação da vida útil restante da bateria
Carregador de pilhas incluído

MAX 10h
4.5h



MAX 1200 LUMEN

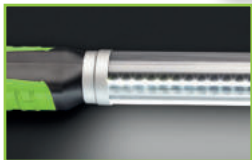

BRIGHT MODE (1200 LM)

MODO CONFORTÁVEL (1100 LM)

SOFT MODE (600 LM)



FG 210/B

€/LISTA
~~85,00~~

PROMO
49,90€

LANTERNA LED DE TUBO PORTÁTIL

Equipado com um projetor de luz superior
Base magnética
Modo de luz vermelha de emergência
Inclui cabo de carregamento USB tipo C
Função de regulação da intensidade da luz

6h
MAX 15h



MAX 1200 LUMEN



486mm



REFLECTOR DE 400 LÚMENS

FUNÇÃO DE BANCO DE POTÊNCIA

SISTEMA DE FIXAÇÃO MAGNÉTICA





LÂMPADAS DE CONTROLO DE COR

SETOR DE CARROÇARIAS



FG 234

€/LISTA ~~105,00~~

PROMO **59,00€**

COB LED - cri 96+
3 COLORI
2700K 4500K 6500K

MAX 3h 3h 1 CE

FAROL DE LED COM ALTO ÍNDICE DE REPRODUÇÃO DE CORES PARA CONTROLE DE CORES

Índice de restituição de cor elevado CRI 96+
3 opções de temperatura de cor 2700K/4500K/6500K
Cabo USB incluído
Dimensões 50x50 mm



SENSOR ON/OFF SEM CONTACTO



4 NÍVEIS DE INCLINAÇÃO

MAX 160 LUMEN

FG 235

€/LISTA ~~135,00~~

PROMO **79,00€**

COB LED - cri 96+
3 COLORI
2700K 4500K 6500K

LÂMPARA DE CABEÇA LED DOBLE CON ALTO ÍNDICE DE REPRODUCCIÓN CROMÁTICA (CRI 96+)

Alto índice de reproducción cromática (IRC) 96+
3 opciones de temperatura de color: 2700K/4500K/6500K
Resistencia al agua y al polvo IP65
Resistencia a impactos IK07
Base de carga de escritorio con puerto USB y cable USB incluido
Dimensiones: 50 x 190 mm



180°



190mm



BASE MAGNÉTICA + TAMPA NA PARTE TRASEIRA



LENTE SUBSTITUÍVEL

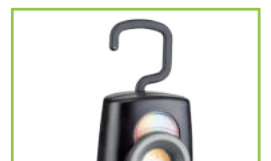

GANCHO EXTRAÍVEL

CE 4h 1 MAX 4h

MAX 500 LUMEN

FG 236

€/LISTA
~~335,00~~

PROMO
209,00€

LUZ LED RECARREGÁVEL PARA CONTROLE DE CORES COM ALTO ÍNDICE DE REPRODUÇÃO DE CORES (CRI 96+)

Elevado índice de restituição de cor CRI 96+

5 opções de temperatura de cor 2700K/3500K/4500K/5500K/6500K

Base giratória de 180

Função de memória dos parâmetros de última utilização

Classificação IP65 de resistência à água e ao pó

Grau de resistência ao impacto IK07

Acessório de tripé não incluído

Dimensões 115x190 mm

LED - cri 96+
5 COLORI

2700K 3500K 4500K 5500K 6500K



MAX 2000 LUMEN

190mm



PAINEL DE CONTROLO



CARREGADOR DE LIBERTAÇÃO RÁPIDA COM CABO DE 5 M



FG 236/SU

€/LISTA
~~100,00~~

PROMO
59,00€

TRIPÉ PARA FAROL DE LED FG 236

Altura 476 mm (fechado) - 1440 mm (aberto)

Número de extensões de pés 3

Carga máxima 2 kg

Peso líquido: 1098 gr



476mm



1440mm

FG 225/SK1.5

€/LISTA
~~300,00~~

PROMO
169,00€

ENROLADOR DE CABO ELÉTRICO AUTOMÁTICO, 15M COM CABO 3GX1.5 MM²

Comprimento do cabo de entrada 1,20 M

15m x 3G 1.5mm² 1000W

230V AC 2000W



LIMITADOR DE RETRAÇÃO PARA MANTER O CARRIL NO LUGAR



SISTEMA DE BLOQUEIO EM QUALQUER COMPRESSÃO



FG 225/SK2.5

€/LISTA
~~370,00~~

PROMO
189,00€

ENROLADOR DE CABO ELÉTRICO AUTOMÁTICO, 15M COM CABO 3GX2.5 MM²

Comprimento do cabo de entrada 1,20 M

15m x 3G 2.5mm² 1600W

230V AC 3200W

SUPORTE DE PAREDE COM ROTAÇÃO DE 360°



POWER TOOLS

DESEMPENHO
CONFIABILIDADE
QUALIDADE



**BRUSHLESS
MOTOR**

**PRESTAZIONI
PERFORMANCE**

**EFFICIENZA
EFFICIENCY**

Descubra a gama de ferramentas elétricas da Fasano Tools, concebidas para satisfazer as necessidades dos utilizadores profissionais. Duas linhas diferentes, com baterias de lítio de 14,4 V e 18 V, respetivamente, desenvolvidas para otimizar o desempenho das ferramentas. Incorporam tecnologia de ponta, com células de elevada

qualidade e sistemas de gestão e proteção inovadores. As ferramentas sem fios da Fasano Tools possuem motores sem escovas e vêm numa robusta mala de transporte com pega antiderrapante e clipe metálico, ideal para guardar e transportar ferramentas e acessórios de forma prática.

GAMA

14.4V

**Li-ion
2Ah**

MANOBRABILIDADE E VERSATILIDADE

A gama de 14,4 V é composta por 7 modelos, todos compatíveis com a mesma bateria de 14,4 V, oferecendo uma grande versatilidade em diferentes situações. Graças ao seu design compacto, estas ferramentas permitem um trabalho confortável e o seu desempenho é suficiente para completar a tarefa no menor tempo possível.



GAMA

18V

**Li-ion
5Ah**

DESEMPENHO MÁXIMO

A linha de 18V inclui ferramentas capazes de oferecer o máximo desempenho para as aplicações mais exigentes. A nova rebarbadora de 125 mm com velocidade variável e a nova aparafusadora compacta de 1/4" completam a gama de 18V, alargando as suas aplicações.



GAMA

18V



FG 330/LT2

~~€LISTA
985,00~~

**PROMO
549,00€**

BERBEQUIM COM PERCUSSÃO - 18V

Motor sem escovas
Alto desempenho, até 135 Nm de binário máximo
Mandril metálico sem chave de 13 mm
11 posições de ajuste de binário
Velocidade dupla
Percussão máxima: 32000 RPM
Velocidade em vazio 0-550/2000 rpm
Luz LED para iluminar a área de trabalho
Embraiagem eletrónica
Sistema Anti Kick Back para máximo controlo da ferramenta
Incluído: 2 baterias de iões de lítio 18V - 5Ah, carregador de bateria, gancho metálico para cinto, pega lateral, mala de transporte em ABS com clipe metálico de fecho



DIMENSÕES



ALTO DESEMPENHO EM TODAS AS APLICAÇÕES

18V CE

**BRUSHLESS
MOTOR**

LI-ION
BATTERY

**135
Nm
MAX
TORQUE**

FG 335/LT2

~~€LISTA
1.110,00~~

**PROMO
599,00€**

NEW

Triturador - 18 V

Motor sem escovas
5 velocidades ajustáveis através de um seletor dedicado
Interruptor deslizante com fecho
Pega lateral ajustável em duas posições
Protetor de segurança de aperto rápido
Grades à prova de poeira
Incluído: 2 pilhas de lítio de 18 V - 5 Ah, carregador de bateria, protetor de segurança, pega lateral, chave de serviço, mala em ABS com clipe de bloqueio em metal



DIMENSÕES



PUNÇÃO LATERAL AUXILIAR



SELETOR DE VELOCIDADE DE 5 POSIÇÕES



18V CE

**BRUSHLESS
MOTOR**

LI-ION
BATTERY

**8.000
MAX RPM**



FG 305/LT2

€/LISTA

~~975,00~~

PROMO

529,00€

CHAVE DE IMPACTO 1/2" - 18V

Motor sem escovas

Binário máximo de 339 Nm ao aparafusar e 475 Nm ao desaparafusar

4 modos de funcionamento

Diâmetro do parafuso M10 - M16

Velocidade em vazio 0-2500 rpm

Função de controlo do aperto para controlo do aperto

Modo de remoção suave do parafuso, evita que o parafuso caia ao desaparafusar

Design compacto

LED tripla para iluminar a área de trabalho

Incluído: 2 baterias de iões de lítio 18V - 5Ah, carregador de bateria,

gancho metálico para cinto, mala de transporte em ABS

com clipe metálico de fecho



DIMENSÕES



TRIPLO LED

18V



1/2"

BRUSHLESS MOTOR



FG 310/LT2

€/LISTA

~~1.075,00~~

PROMO

559,00€

CHAVE DE IMPACTO 1/2" - 18V

Motor sem escovas

Binário máximo de 746 Nm ao aparafusar e 881 Nm ao desaparafusar

4 modos de funcionamento

Diâmetro do parafuso M16 - M22

Velocidade em vazio 0-2200 rpm

Função de controlo do aperto para controlo do aperto

Modo de remoção suave do parafuso, evita que o parafuso caia ao desaparafusar

Design compacto

LED tripla para iluminar a área de trabalho

Incluído: 2 baterias de iões de lítio 18V - 5Ah, carregador de

bateria, gancho metálico para cinto, mala de transporte em ABS

com clipe metálico de fecho



DIMENSÕES



TRIPLO LED

18V



1/2"

BRUSHLESS MOTOR



FG 315/LT2

€/LISTA

~~1.175,00~~

PROMO

599,00€

CHAVE DE IMPACTO 1/2" - 18V

Motor sem escovas

Binário máximo de 949 Nm ao aparafusar e 2169 Nm ao desaparafusar

4 modos de funcionamento

Diâmetro do parafuso M12 - M32

Velocidade em vazio 0-1800 rpm

Função de controlo do aperto para controlo do aperto

Modo de remoção suave do parafuso, evita que o parafuso

caia ao desaparafusar

Design compacto

LED tripla para iluminar a área de trabalho

Incluído: 2 baterias de iões de lítio 18V - 5Ah, carregador de

bateria, gancho metálico para cinto, mala de transporte em ABS

com clipe metálico de fecho



DIMENSÕES



TRIPLO LED

18V



1/2"

BRUSHLESS MOTOR



FG 320/LT2

€/LISTA
1.225,00

PROMO
669,00€

CHAVE DE IMPACTO 3/4" - 18V

Motor sem escovas
Binário máximo de 949 Nm ao aparafusar e 2169 Nm ao desaparafusar
4 modos de funcionamento
Diâmetro do parafuso M12 - M32
Velocidade em vazio 0-1750 rpm
Função de controlo do aperto para controlo do aperto
Modo de remoção suave do parafuso, evita que o parafuso caia ao desaparafusar
Design compacto
LED tripla para iluminar a área de trabalho
Incluído: 2 baterias de iões de lítio 18V - 5Ah, carregador de bateria, gancho metálico para cinto, mala de transporte em ABS com clipe metálico de fecho



DIMENSÕES



TRIPLO LED

18V CE

3/4" **BRUSHLESS**
MOTOR

LI-ION BATTERY

1800
Nm
MAX
TORQUE

FG 325/LT2

€/LISTA
985,00

PROMO
549,00€

NEW

APARAFUSADORA DE IMPACTO 1/4" - 18V

Motor sem escovas
Controlo de potência: 3 velocidades + 2 modos dedicados (madeira e parafusos) para ajustar o desempenho de acordo com as aplicações
Design compacto
Encaixe hexagonal fêmea de 1/4"
225 Nm de binário máximo
Diâmetro standard do parafuso M5 - M16
Velocidade em vazio 0-1900/2800/3600 rpm
Três LEDs para iluminar a área de trabalho
Equipamento: 2 baterias de lítio 18V - 5 Ah, carregador, gancho de metal para cinto, mala em ABS com fecho de metal



DIMENSÕES



TRIPLO LED

18V CE

1/4" **BRUSHLESS**
MOTOR

LI-ION BATTERY

225
Nm
MAX
TORQUE

GAMA DE INTERRUPTORES DE IMPACTO DE 18V



FG 325/LT2

FG 305/LT2

FG 310/LT2

FG 315/LT2

FG 320/LT2

	FG 325/LT2	FG 305/LT2	FG 310/LT2	FG 315/LT2	FG 320/LT2
TECNOLOGIA DO MOTORES	Brushless	Brushless	Brushless	Brushless	Brushless
ATAQUE	Hexagonal fêmea 1/4"	Cuadrado macho 1/2"	Cuadrado macho 1/2"	Cuadrado macho 1/2"	Cuadrado macho 3/4"
BATERIA	18V - 5Ah	18V - 5Ah	18V - 5Ah	18V - 5Ah	18V - 5Ah
TORQUE MÁXIMO PARAFUSADO (NM)	225	470	740	950	950
TORQUE MÁXIMO DESPARAFUSADO (NM)	-	510	880	1800	1800
Ø PARAFUSO	M5-M16	M10-M16	M16-M22	M12-M32	M12-M32
VEL. VAZIO (RPM)	0-3600	0-2500	0-2200	0-1800	0-1750
PESO COM BATERIA (GR)	1.600	1.890	2.360	3.450	3.560



GAMA

14.4V

FG 360/LT1

€/LISTA

~~505,00~~

PROMO
299,00€

ROQUETE 1/2" - 14,4V

Motor sem escovas

Elevado desempenho, binário máximo até 95 Nm

Cabeça fina

Velocidade variável

Luz LED para iluminar a área de trabalho

Incluído: 1 bateria de lítio 14,4V - 2Ah, 1 carregador de bateria, mala de transporte em ABS com clip de fecho metálico

14.4V CE

BRUSHLESS MOTOR

LI-ION BATTERY



DIMENSÕES



CABEÇA FINA PARA MÁXIMA ACESSIBILIDADE

FG 363/LT1

€/LISTA

~~530,00~~

PROMO
319,00€

ROQUETE 3/8" - 14,4V

Motor sem escovas

Elevado desempenho, binário máximo até 95 Nm

Cabeça fina

Velocidade variável

Luz LED para iluminar a área de trabalho

Incluído: 1 bateria de lítio 14,4V - 2Ah, 1 carregador de bateria, mala de transporte em ABS com clip de fecho metálico

14.4V CE

BRUSHLESS MOTOR

LI-ION BATTERY



DIMENSÕES



DESENHO LONGO PARA ACEDER AOS LOCAIS MAIS DIFÍCEIS

FG 366/LT1

€/LISTA

~~535,00~~

PROMO
319,00€

ROQUETE LONGO DE 1/4" - 14,4V

Motor sem escovas

Máxima eficiência, até 61 Nm de binário máximo a uma velocidade de 500 rpm

Design longo

Velocidade variável

Luz LED para iluminar a área de trabalho

Incluído: 1 bateria de lítio 14,4V - 2Ah, 1 carregador de bateria, mala de transporte em ABS com clip de fecho metálico

14.4V CE

BRUSHLESS MOTOR

LI-ION BATTERY



DIMENSÕES



DESENHO LONGO PARA ACEDER AOS LOCAIS MAIS DIFÍCEIS

FG 370/LT1

€/LISTA
~~639,00~~

PROMO
379,00€

LIXADORA DE CINTA - 14,4V 10X330MM

Motor sem escovas
Correia 10x330 mm
Velocidade variável
Design leve e ergonómico
Luz LED para iluminar a área de trabalho
Incluído: 1 bateria de lítio 14,4V - 2Ah, 1 carregador de bateria,
mala de transporte em ABS com clip de fecho metálico



DIMENSÕES



BRAÇO GIRATÓRIO DE 360°

14.4V



BRUSHLESS
MOTOR



FG 373/LT1

€/LISTA
~~615,00~~

PROMO
369,00€

LIXADORA DE CINTA - 14,4V 20X520MM

Motor sem escovas
Correia 20x520 mm
Velocidade variável
Design leve e ergonómico
Luz LED para iluminar a área de trabalho
Incluído: 1 bateria de lítio 14,4V - 2Ah, 1 carregador de bateria,
mala de transporte em ABS com clip de fecho metálico



DIMENSÕES



BRAÇO GIRATÓRIO DE 360°

14.4V



BRUSHLESS
MOTOR



FG 380/LT1

€/LISTA
~~539,00~~

PROMO
319,00€

MINI MOINHO RETO 14,4V

Motor sem escovas
4 velocidades
Design compacto
Cabeça reta com ligação de pinça de 6 mm
Diâmetro máximo do disco 55 mm
Luz LED para iluminar a área de trabalho
Incluído: 1 bateria de íões de lítio 14,4V - 2Ah, 1 carregador de bateria,
mala de transporte em ABS com clipe de fecho metálico



DIMENSÕES



PAINEL DE CONTROLO DA VELOCIDADE DE TRABALHO

14.4V



BRUSHLESS
MOTOR



FG 383/LT1

€/LISTA
~~535,00~~

PROMO
299,00€

MINI REBARBADORA 14,4V

Motor sem escovas
4 velocidades
Design compacto
Cabeça reta com ligação de pinça de 6 mm
Diâmetro máximo do disco 55 mm
Luz LED para iluminar a área de trabalho
Incluído: 1 bateria de íões de lítio 14,4V - 2Ah, 1 carregador de bateria,
mala de transporte em ABS com clipe de fecho metálico



DIMENSÕES



PAINEL DE CONTROLO DA VELOCIDADE DE TRABALHO

14.4V



BRUSHLESS
MOTOR





EXTRACTORES



FG 162/S3

€/LISTA
~~366,00~~

PROMO
229,00€

JOGO DE 3 EXTRACTORES UNIVERSAIS

Soquete externo

Mandíbulas deslizantes em aço cromo-vanádio

Conteúdo:

A/mm 15-85 - A/mm 100

A/mm 15-125 - A/mm 100

A/mm 20-160 - A/mm 150



EXTRACTOR DE 2 PERNAS FINAS

Mordentes intercambiáveis super-finos de 2 mm em aço cromo-vanádio

Punho interno e externo

Parafuso em aço cromo-vanádio



CÓDIGO	A/MM	B/MM	C/MM	€/LISTA	€/PROMO
FG 168/EF1	110	140	186	340,00	209,00€
FG 168/EF2	195	140	186	350,00	215,00€

FG 163/S2B

€/LISTA
~~263,00~~

PROMO
159,00€

KIT EXTRATOR PARA TOMADA INTERNA - EXTERNA

7 - 140/23 - 130 (para tomada externa)

40 - 180 (para tomada interna)

Mandíbulas autoajustáveis em aço cromo-vanádio



EXTRACTOR DE 2/3 PERNAS

Equipado com 3 mordentes para agarrar no interior e 3 mordentes para agarrar no exterior

Mordentes em aço cromo-vanádio



CÓDIGO	Ø INTERNA	Ø EXTERNA	€/LISTA	€/PROMO
FG 165/IE1	25-100mm	0-75mm	325,00	199,00€
FG 165/IE2	45-150mm	40-130mm	760,00	459,00€

EXTRACTOR DE PERCUSSÃO
M12x1.5



CÓDIGO	PARA	€/LISTA	€/PROMO
FG 165/MB1	FG 165/IE1	170,00	99,00€
FG 165/MB2	FG 165/IE2	330,00	199,00€

FG 168SD/54

€/LISTA
~~162,00~~

PROMO
99,00€

JOGO 4 QUEBRA PORCAS

Conteúdo: FG 168/SD1 -SD2-SD3-SD4



JOGO DE EXTRAÇÃO PARA PORCAS DIREITAS DANIFICADAS COM LIGAÇÃO DE 1/2

Fornecido num suporte em ABS suspensível com ganchos de fixação e mecanismo de interruptor de limite anti-queda

1/2"



CÓDIGO	CONTEÚDO	€/LISTA	€/PROMO
FG 168A/S5	22, 24, 27, 30, 32 mm	115,00	69,00€
FG 168A/S13	8, 9, 10, 11, 12, 13, 14, 15, 16, 17, 18, 19, 21 mm	220,00	129,00€

FG 168EP/55

€/LISTA
~~35,00~~

PROMO
21,00€

EXTRACTORES CÔNICOS DE PARAFUSOS EM AÇO LIGADO
Inserção por percussão



FG 168/S25

€/LISTA
~~145,00~~

PROMO
89,00€

EXTRACTORES CÔNICOS DE PARAFUSOS EM AÇO LIGADO

Equipado com guias internas e externas e brocas
Utilização: parafusos com diâmetro 6-16mm

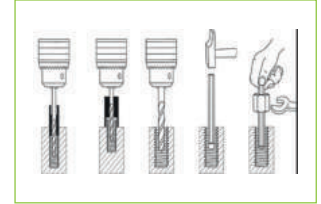

FG 168/S9

€/LISTA
~~188,00~~

PROMO
119,00€

JOGO 9 SACA PERNOS COM ROLETE

Conteúdo: FG 168/R6 - R16



FG 182/S5B

€/LISTA
~~475,00~~

PROMO
289,00€

JOGO EXTRACTORES DE PERCUSSÃO E ACESSÓRIOS



FG 182/S14

€/LISTA
~~248,00~~

PROMO
149,00€

JOGO DE EXTRACTORES DE ROLAMENTOS DE ESFERAS

Ø/mm 5,6,8,9,11,12,5





FERRAMENTAS PNEUMÁTICAS



FGA 307

€/LISTA
~~250,00~~

PROMO
149,00€

CHAVE DE IMPACTO-1/2"

- 766 Nm MAX
- 670 Nm MAX
- Aire/Air → 136 L/min
- 9.500 MAX RPM
- 1200gr
- 6.2 Bar



MARTILLO ÚNICO

1.085 Nm
MAX TORQUE



FGA 307/AN

€/LISTA
~~340,00~~

PROMO
199,00€

CHAVE DE IMPACTO ANGULAR -1/2"

- 420 Nm MAX
- 204 Nm MAX
- Aire/Air → 113 L/min
- 9.000 MAX RPM
- 1150gr
- 6.2 Bar



MARTILLO ÚNICO

680 Nm
MAX TORQUE



FGA 309

€/LISTA
~~300,00~~

PROMO
179,00€

CHAVE DE IMPACTO-1/2"

- 1.085 Nm MAX
- 766 Nm MAX
- Aire/Air → 151 L/min
- 7.300 MAX RPM
- 1900gr
- 6.2 Bar



DOBLE MARTILLO

1.700 Nm
MAX TORQUE



FGA 312

€/LISTA
~~380,00~~

PROMO
219,00€

CHAVE DE IMPACTO-1/2"

- 1130 Nm MAX
- 950 Nm MAX
- Aire/Air → 136 L/min
- 7.500 MAX RPM
- 2000gr
- 6.2 Bar



DOBLE MARTILLO

2.000 Nm
MAX TORQUE



FGA 316

CHAVE DE IMPACTO DE 3/4"

€/LISTA
~~769,00~~

PROMO
459,00€



DOBLE MARTILLO

CE

FGA 316/L

CHAVE DE IMPACTO DE 3/4" - ÁRVORE LONGO 6"

€/LISTA
~~850,00~~

PROMO
529,00€

1890 Nm MAX	1627 Nm MAX	AIR/AIR 229 L/min	3300gr	5.300 MAX RPM	6.2 Bar
			3890gr		

FGA 319

CHAVE DE IMPACTO DE 1"

€/LISTA
~~1.250,00~~

PROMO
699,00€



PIN-LESS

CE

FGA 319/L

CHAVE DE IMPACTO DE 1" - ÁRVORE LONGO 6"

€/LISTA
~~1.350,00~~

PROMO
739,00€

2700 Nm MAX	2500 Nm MAX	AIR/AIR 271 L/min	10200gr	4.800 MAX RPM	6.2 Bar
			11100gr		

FGA 321

CHAVE DE IMPACTO DE 1"

€/LISTA
~~1.200,00~~

PROMO
659,00€



DOBLE MARTILLO

CE

FGA 321/B

CHAVE DE IMPACTO DE 1" - ÁRVORE LONGO 6"

€/LISTA
~~1.250,00~~

PROMO
689,00€

2983 Nm MAX	2576 Nm MAX	5.500 MAX RPM	AIR/AIR 340 L/min	6800gr	6.2 Bar
				7700gr	

FGA 321/C

CHAVE DE IMPACTO DE 1" - ÁRVORE LONGO 6"

€/LISTA
~~1.350,00~~

PROMO
719,00€



PIN-LESS

CE

RECOMENDADO PARA USO INTENSIVO



FERRAMENTAS PNEUMÁTICAS

FGA 290

€/LISTA
~~205,00€~~

PROMO
129,00€

ROQUETE PNEUMÁTICO 1/4"

Sistema de reversibilidade integrado na cabeça
Sistema de acionamento da pinça
Ligação de ar 1/4" gás



FGA 291/D

€/LISTA
~~198,00~~

PROMO
125,00€

MINI ROQUETE PNEUMÁTICO 1/4"

Ligação de ar 1/4" gás
Mangueira de ar interna Ø 10mm (3/8")



TAMANHO PEQUENO: APENAS 125 mm



FGA 292/B

€/LISTA
~~225,00~~

PROMO
139,00€

ROQUETE PNEUMÁTICO 1/2"



FERRAMENTAS SEMPRE EFICIENTES

Para as ferramentas pneumáticas da Fasano Tools, estão disponíveis no catálogo kits de manutenção de rotina para otimizar o seu trabalho, mantendo as ferramentas sempre organizadas e eficientes

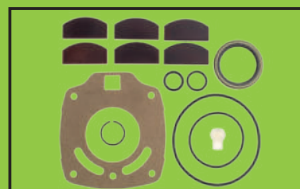
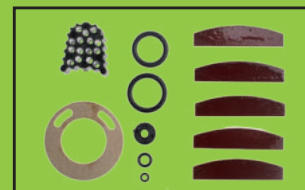
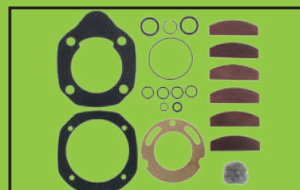

FGA 322

€/LISTA
~~140,00€~~

PROMO
89,00€

VULCANIZER PNEUMÁTICO



FGA 390

€/LISTA
~~162,00~~

PROMO
99,00€

MANÔMETRO

Corpo em alumínio niquelado
Revestimento de borracha resistente ao óleo
Manômetro Ø80 (0-10bar)
Proteção contra sobrepresão
Alavanca de drenagem/insuflação de duas posições
Comprimento do tubo: 500 mm





CARRETEL DE MANGUEIRA

FGA 383/AR15

€/LISTA
~~275,00~~

PROMO
149,00€

ENROLADOR TUBO AUTOMÁTICO PARA AR COMPRIMIDO -15MT

Tubo Ø: 8x12mm

Conexión de salida macho de 1/4"

Conexión de entrada macho de 1/4"

FGA 385/AR15

€/LISTA
~~360,00~~

PROMO
199,00€

ENROLADOR TUBO AUTOMÁTICO PARA AR COMPRIMIDO -15MT

Tubo Ø: 10x13mm

Conexión de salida macho de 3/8"

Conexión de entrada macho de 3/8"

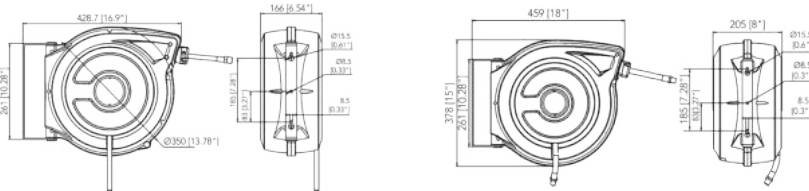

**TUBO DE MALHA DE POLIURETANO
SUPORTE DE PAREDE GIRATÓRIO 360°**



Guia de rolagem automática

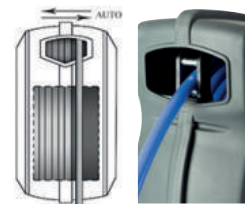

Sistema de bloqueio em qualquer comprimento



Rebobinagem com velocidade controlada



FGA 419

€/LISTA
~~25,50~~

PROMO
15,90€

SOPRADOR

Válvula de abertura progressiva

Corpo em alumínio niquelado

Pega de borracha antiderrapante



FGA 416

€/LISTA
~~24,00~~

PROMO
14,90€

SOPRADOR

Válvula de abertura progressiva

Rosca em latão





FERRAMENTAS PNEUMÁTICAS

LIXADEIRA DE DISCO ORBITAL

- 152mm
- 11000 MAX RPM
- 900gr
- 45.2 L/min
- 6.2 Bar

- 150mm
- 11000 MAX RPM
- 800gr
- 46 L/min
- 6.2 Bar



CÓDIGO		€/LISTA	€/PROMO
FGA 340	Ø placa de lijado 152mm	295,00€	179,00€
FGA 340/B	Ø placa de lijado 150mm	305,00€	189,00€



FGA 342/B

€/LISTA
~~285,00~~

PROMO
179,00€

LIXADEIRA DE DISCO ORBITAL

Órbita Ø: 2.5 mm
Almofada de apoio 3 furos suministrado



- 75mm
- 11000 MAX RPM
- 500gr
- 46 L/min
- 6.2 Bar

FGA 344

€/LISTA
~~250,00~~

PROMO
159,00€

HERRAMIENTA PARA QUITAR VIDRIO CON CUCHILLA OSCILANTE

Fornecido com uma lâmina de 57mm (FGA 344/LS1)

Transportador de saída de ar

Ligação de ar 1/4" a gás

Mangueira de ar interna Ø 10mm (3/8")



- 20.000 MAX RPM
- 0.50 Hp
- 1060gr
- 6.2 Bar



FGA 342

€/LISTA
~~230,00~~

PROMO
139,00€

LIXADEIRA DE DISCO ORBITAL

Diâmetro da órbita: 2 mm
Inclui 3 almofadas



- 74 L/min
- 13000 MAX RPM
- 500gr
- 6.2 Bar

FGA 343/N10

€/LISTA
~~235,00~~

PROMO
149,00€

LIXADEIRA DE CINTA

Tamanho da fita: 10x330mm

Inclui 3 fitas

3 cintas incluídas



- 0.70 Hp
- 18000 MAX RPM
- 90 L/min
- 800gr
- 6.2 Bar

FGA 343/N20

€/LISTA
~~315,00~~

PROMO
199,00€

LIXADEIRA DE CINTA

Tamanho da fita: 20x520mm

Inclui 3 fitas

3 cintas incluídas



- 0.70 Hp
- 18000 MAX RPM
- 107 L/min
- 960gr
- 6.2 Bar

FGA 337

€/LISTA
~~139,00~~

PROMO
79,00€

LIXADEIRA PARA REMOVER BORRACHA



FGA 330

€/LISTA
~~295,00~~

PROMO
179,00€

SERRA PNEUMÁTICA

Cuerpo de aluminio recubierto de goma antideslizante
Protector frontal de la cuchilla de acero



FGA 339

€/LISTA
~~355,00~~

PROMO
219,00€

REBARBADORA - Ø DISCO: 115MM

Capacidade do disco: 115 mm
Sistema de regulação da velocidade da pinça



FGA 332

€/LISTA
~~145,00~~

PROMO
89,00€

BERBEQUIM REVERSÍVEL - BUCHA DE APERTO RÁPIDO: 1-10MM

Mandril autoajustable de 1 a 10 mm (3/8")
Mandril auto-apertante de 1 a 10 mm (3/8")



FGA 335

€/LISTA
~~219,00~~

PROMO
125,00€

REBITADORA PNEUMÁTICA

4 cabeças intermutáveis



FGA 336

€/LISTA
~~649,00~~

PROMO
409,00€

REBITADORA PNEUMÁTICA

4 cabeças intermutáveis





FERRAMENTAS PNEUMÁTICAS

FGA 346/B

€/LISTA
~~235,00~~

PROMO
149,00€

MICRO RECTIFICADORA
Capacidade da pinça: 3 mm



FGA 334

€/LISTA
~~145,00~~

PROMO
89,00€

RECTIFICADORA PNEUMÁTICA
Capacidade da pinça: 3 mm



LÂMINAS DE KEVLAR



FGA 338

€/LISTA
~~125,00~~

PROMO
79,00€

RECTIFICADORA PNEUMÁTICA
Cuerpo de acero recubierto de goma antideslizante
Capacidade da pinça: 3 mm



LÂMINAS DE KEVLAR



FGA 334/AN115

€/LISTA
~~185,00~~

PROMO
109,00€

RECTIFICADORA PNEUMÁTICA-115°
Capacidade da pinça: 3 mm



LÂMINAS DE KEVLAR



FGA 338/AN

€/LISTA
~~180,00~~

PROMO
109,00€

RECTIFICADORA PNEUMÁTICA ANGULAR
Cuerpo de acero recubierto de goma antideslizante
Capacidade da pinça: 6mm



LÂMINAS DE KEVLAR



FGA 334/AN

€/LISTA
~~185,00~~

PROMO
109,00€

RECTIFICADORA PNEUMÁTICA ANGULAR
Capacidade da pinça: 3 mm



LÂMINAS DE KEVLAR



FGA 338/L

€/LISTA
~~175,00~~

PROMO
109,00€

RECTIFICADORA PNEUMÁTICA LONGA
Cuerpo de acero recubierto de goma antideslizante
Capacidade da pinça: 6mm



LÂMINAS DE KEVLAR



FGA 334/L

€/LISTA
~~185,00~~

PROMO
109,00€

RECTIFICADORA PNEUMÁTICA LONGA
Capacidade da pinça: 3 mm



LÂMINAS DE KEVLAR



GAMA AIR COMPACT

Design compacto e desempenho otimizado para um trabalho eficiente, rápido e preciso.



FGA 348/A

€/LISTA
~~180,00~~

PROMO
109,00€

LIXADORA RETA COM GRAMPO

Design leve e compacto
Capacidade da pinça: 6 mm (1/4")
Ligação de ar: gás de 1/4"
Diâmetro da mangueira de ar interior: 10 mm (3/8")



— TAMANHO PEQUENO: APENAS 125 mm —



FGA 348/C

€/LISTA
~~250,00~~

PROMO
159,00€

LIXADORA ANGULAR - Ø DISCO 51MM

Design leve e compacto
Ligação de ar: gás de 1/4"
Diâmetro interior da mangueira de ar: 10 mm (3/8")
Diâmetro do furo do disco de esmeril a utilizar: 9,5 mm
Um disco de 2 mm e um disco de 3 mm incluídos



— TAMANHO PEQUENO: APENAS 125 mm —



FGA 348/B

€/LISTA
~~210,00~~

PROMO
129,00€

LIXADORA ANGULAR COM GRAMPO

Design leve e compacto
Capacidade da pinça: 6 mm (1/4")
Ligação de ar: gás de 1/4"
Diâmetro da mangueira de ar interior: 10 mm (3/8")



— TAMANHO PEQUENO: APENAS 125 mm —



FGA 348/D

€/LISTA
~~280,00~~

PROMO
179,00€

LIXADORA ORBITAL

Design leve e compacto
Ligação de ar: gás de 1/4"
Diâmetro interior da mangueira de ar: 10 mm (3/8")
Rosca: 5/16" - 24 UNF
Diâmetro da base de apoio: 51 mm (incluída)



— TAMANHO PEQUENO: APENAS 125 mm —



O MELHOR DE MADE IN ITALY



Os nossos automóveis são o resultado de uma intensa investigação, desenvolvimento, design e produção interna.

ROBUSTEZ E FUNCIONALIDADE SÃO AS CARACTERÍSTICAS QUE DISTINGUEM OS NOSSOS CARRINHOS DE FERRAMENTAS

Uma gama completa de modelos que diferem no design, cores e funcionalidades para oferecer aos utilizadores as melhores soluções possíveis de acordo com as suas necessidades



GAVETAS COMPATÍVEIS COM
TODOS OS MATERIAIS
TERMOFORMADAS PELA FASANO TOOLS

FG 102



FG 100



FG 122



FG 150



PADRÃO
DISPONÍVEL COM 5, 6, 7 E 8 GAVETAS
EM 5 CORES + 14 CORES FG 100 BICOLOR



FG 104



FG 124



XL
DISPONÍVEL COM 6-7 GAVETAS
EM 4 CORES

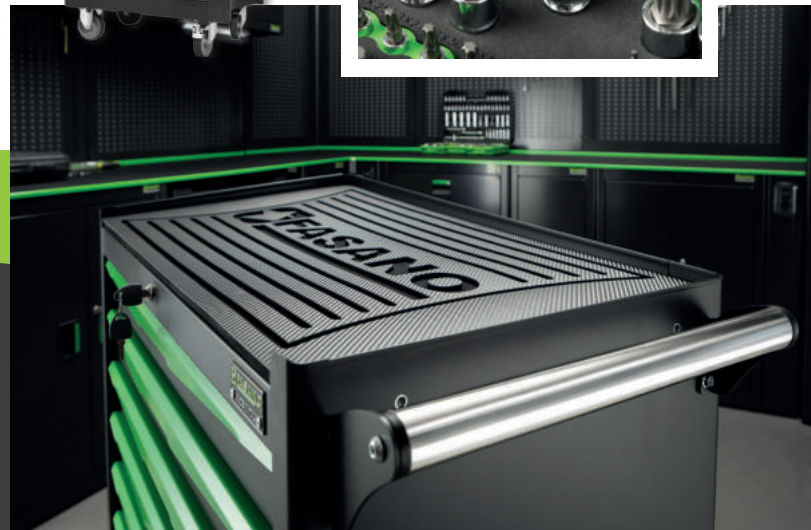

FG 125



FG 126



FG 162V/14L



FG 162V/14P



**CAPACIDADE
MÁXIMA
2400 kg**

COM APÊNDICE LATERAL
DISPONÍVEL EM 4 VARIAÇÕES DE CORES

COM BANCADA INDIVIDUAL
FABRICADO EM CHAPA DE AÇO DE 2 MM DE ESPESURA COM TAMPO EM POLICARBONATO OU CONTRAPLACADO DE CHOUPO COM 18 MM DE ESPESURA
DISPONÍVEL EM 4 CORES COM 14 GAVETAS.

QUALIDADE QUE DURA

**CARRINHOS PARA FERRAMENTAS FASANO
FACILITAM O SEU TRABALHO:
SÃO FABRICADOS COM A MÁXIMA ATENÇÃO AOS
DETALHES PARA ARMAZENAR
AS SUAS FERRAMENTAS DE FORMA FIÁVEL E PRÁTICA**

**A PEGA LATERAL EM AÇO E AS RODAS
EM BORRACHA VULCANIZADA TORNAM
OS CARRINHOS FÁCEIS DE MANOBRAR
E TRANSPORTAR**

**LA CHAPA DE ACERO DE 10/10 DE ESPESOR
GARANTIZA SOLIDEZ, ESTABILIDAD Y ROBUSTEZ**



AS GAVETAS ESTÃO EQUIPADAS COM:

**PUXADORES EM CHAPA DE AÇO
ABERTURA TOTAL
GUIAS TELESCÓPICAS COM SISTEMA DE FECHO SUAVE
TAPETES DE PROTEÇÃO ANTIDERRAPANTES E ANTIRRISCOS**

**CAPACIDADE DA GAVETA:
45 KG NA VERSÃO STANDARD
60 KG NA VERSÃO XL**



DIVISÓRIAS DE GAVETA

**DISPOSITIVO DE DIVISÓRIAS INTERNAS
PARA ORGANIZAR PEÇAS PEQUENAS**

**PARA GARANTIR A ORDEM
E PRECISÃO NO SEU TRABALHO!**





CARRINHOS DE FERRAMENTAS

CADA DETALHE FAZ A DIFERENÇA EM TERMOS DE FORÇA E RESISTÊNCIA AO LONGO DO TEMPO



PARTE SUPERIOR EM BORRACHA COM ACABAMENTO EM CARBONO 3D



GAVETA COM EXTENSÃO TOTAL E MECANISMO DE FECHO SUAVE.



NOVO SISTEMA DE PRATELEIRAS PARA MAIOR ABERTURA E MAIS NÍVEIS DE GAVETAS



RODAS REVESTIDAS COM BORRACHA VULCANIZADA (2 FIXAS + 2 GIRATÓRIAS, 1 COM TRAVÃO)

FG 122



CARRINHO DE FERRAMENTAS FG 122

Caixa electrosoldada
Guias telescópicas com sistema de acoplamento automático
4 rodas de borracha vulcanizada Ø125mm (2 giratórias, 1 com travão)
Piso superior de borracha com acabamento em carbono 3D
Sistema de fecho centralizado
Gavetas equipadas com tapetes anti-riscos e previsão de divisórias interiores
Abertura total das gavetas
Puxador em aço inoxidável
Capacidade máxima gavetas: 45Kg



CÓDIGO	Gavetas	Peso/Kg	€/lista	€/PROMO
FG 122V/5G	5	65	1.030,00	539,00€
FG 122V/6G	6	69	1.080,00	569,00€
FG 122V/7G	7	71	1.150,00	599,00€

FG 122/PC

NEW

SUPORTE PARA PC

Per FG 102, FG 104, FG 105, FG 109, FG 122, FG 124, FG 125, FG 126
Dobrável



€/LISTA

~~80,00~~

PROMO

49,00€

FG 122/PL

NEW

PORTA LATAS

Per FG 122, FG 124, FG 125, FG 126



€/LISTA

~~58,00~~

PROMO

34,90€

FG 100/PR

PORTA PAPEL

Per FG 100, FG 122, FG 124, FG 125, FG 126



€/LISTA

~~62,00~~

PROMO

39,00€

FG 124



CARRINHO DE FERRAMENTAS FG 124

Caixa electrosoldada
Guias telescópicas com sistema de acoplamento automático
4 rodas de borracha vulcanizada Ø125mm (2 giratórias, 1 com travão)
Piso superior de borracha com acabamento em carbono 3D
Sistema de fecho centralizado
Gavetas equipadas com tapetes anti-riscos e previsão de divisórias interiores
Abertura total das gavetas
Puxador em aço inoxidável
Capacidade maxima gavetas: 60Kg



800 Kg **PORTATA STATICA**

CÓDIGO				Gavetas	Peso/Kg	€/lista	€/PROMO
FG 124V/6G	FG 124D/6G	FG 124B/6G	FG 124R/6G	6	82	1.300,00	659,00€
FG 124V/7G	FG 124D/7G	FG 124B/7G	FG 124R/7G	7	85	1.400,00	699,00€

FG 125

NEW



CARRINHO DE FERRAMENTAS FG 125

Caixa electrosoldada
Guias telescópicas com sistema de acoplamento automático
4 rodas de borracha vulcanizada Ø125mm (2 giratórias, 1 com travão)
Piso superior de borracha com acabamento em carbono 3D
Sistema de fecho centralizado
Gavetas equipadas com tapetes anti-riscos e previsão de divisórias interiores
Abertura total das gavetas
Puxador em aço inoxidável
Capacidade maxima gavetas: 45Kg



800 Kg **PORTATA STATICA**

CÓDIGO				Gavetas	Peso/Kg	€/lista	€/PROMO
FG 125V/5G	FG 125D/5G	FG 125B/5G	FG 125R/5G	5	86	1.460,00	789,00€
FG 125V/6G	FG 125D/6G	FG 125B/6G	FG 125R/6G	6	90	1.510,00	819,00€
FG 125V/7G	FG 125D/7G	FG 125B/7G	FG 125R/7G	7	92	1.580,00	849,00€

FG 126

NEW



CARRINHO DE FERRAMENTAS FG 126

Caixa electrosoldada
Guias telescópicas com sistema de acoplamento automático
4 rodas de borracha vulcanizada Ø125mm (2 giratórias, 1 com travão)
Piso superior de borracha com acabamento em carbono 3D
Sistema de fecho centralizado
Gavetas equipadas com tapetes anti-riscos e previsão de divisórias interiores
Abertura total das gavetas
Puxador em aço inoxidável
Capacidade maxima gavetas: 60Kg



800 Kg **PORTATA STATICA**

CÓDIGO				Gavetas	Peso/Kg	€/lista	€/PROMO
FG 126V/6G	FG 126D/6G	FG 126B/6G	FG 126R/6G	6	103	1.730,00	899,00€
FG 126V/7G	FG 126D/7G	FG 126B/7G	FG 126R/7G	7	106	1.830,00	949,00€



CARRINHOS E BANCADAS DE TRABALHO

FG 123



CARRINHO DE FERRAMENTAS FG 123

Caixa electrosoldada
 Guias telescópicas com sistema de acoplamento automático
 4 rodas de borracha vulcanizada Ø125mm (2 giratórias, 1 com travão)
 Piso superior de borracha com acabamento em carbono 3D
 Sistema de fecho centralizado
 Gavetas equipadas com tapetes anti-riscos e previsão de divisórias interiores
 Abertura total das gavetas
 Puxador em aço inoxidável
 Capacidade maxima gavetas: 45Kg

NEW



800 Kg PORTATA STATICA

CÓDIGO				Gavetas	Peso/Kg	€/lista	€/PROMO
FG 123V/5G	FG 123B/5G	FG 123R/5G	FG 123D/5G	5	81	1.430,00	739,00€
FG 123V/6G	FG 123B/6G	FG 123R/6G	FG 123D/6G	6	85	1.480,00	769,00€
FG 123V/7G	FG 123B/7G	FG 123R/7G	FG 123D/7G	7	87	1.550,00	799,00€



GABINETE SUPERIOR EQUIPADO COM PISTÕES A GÁS



GRADE DE SUPORTE DE FERRAMENTAS



DISPOSIÇÃO PARA DIVISÓRIAS INTERNAS

FG 100



CARRINHO DE FERRAMENTAS FG 100

Corrediças telescópicas com sistema de acoplamento automático
 4 rodas de borracha vulcanizada Ø125mm (2 fixas e 2 giratórias)
 Fechos laterais centralizados
 Prateleira superior em ABS e porta-ferramentas laterais
 Porta-garrafas lateral de série
 Painéis laterais com orifícios para pendurar ganchos para ferramentas
 Capacidade maxima gavetas: 45Kg

800 Kg PORTATA STATICA



CÓDIGO					Gavetas	Peso/Kg	€/lista	€/PROMO
FG 100V/5T	FG 100B/5T	FG 100R/5T	FG 100D/5T	FG 100W/5T	5	58	1.000,00	539,00€
FG 100V/6T	FG 100B/6T	FG 100R/6T	FG 100D/6T	FG 100W/6T	6	60	1.050,00	569,00€
FG 100V/7T	FG 100B/7T	FG 100R/7T	FG 100D/7T	FG 100W/7T	7	62	1.100,00	599,00€



SISTEMA DE BLOQUEIO LATERAL



NOVO CABO DE AÇO



GAVETA COM ABERTURA TOTAL



FG 162



CARRINHO DE FERRAMENTAS COM 14 GAVETAS FG 162

- Guias telescópicas con sistema de acoplamiento automático
- Correijas telescópicas com fecho suave
- Puxador lateral em aço
- Suporte para rolos e suporte para latas incluídos
- Gavetas com tapetes de borracha no interior
- Painéis laterais com orifícios para ganchos de ferramentas
- Prateleira superior em chapa metálica de 2 mm com tampo em policarbonato
- 4 rodízios revestidos a borracha vulcanizada, Ø160 mm (2 fixos, 2 giratórios com travão)
- Portas com abertura de 110°, equipadas com fechadura e duas prateleiras interiores amovíveis
- Suporte lateral para ferramentas (530 x 240 mm)
- Capacidade da gaveta: 60 kg



2400 Kg PORTATA STATICA



CÓDIGO	Gavetas	Peso/kg	€/lista	€/PROMO
FG 162V/14P	14	193	3.300,00	1.799,00€
FG 162D/14P				
FG 162B/14P				
FG 162R/14P				



A PORTA ABRE A 110°



CABO DE AÇO INOXIDÁVEL



CAIXAS COM PREVISÃO PARA DIVISÓRIAS PARA PEÇAS PEQUENAS

FG 162

NEW

CARRINHO DE FERRAMENTAS COM 14 GAVETAS FG 160

- Guias telescópicas de cierre suave
- Asa lateral de acero
- Portarrollos y portalatas incluidos
- Cajones con alfombrillas de goma interiores
- Paneles laterales con orificios para ganchos para herramientas
- Encimera de contrachapado de álamo de 18 mm
- 4 ruedas de 160 mm de diámetro con revestimiento de goma vulcanizada (2 fijas y 2 giratorias con freno)
- Puertas con apertura de 110°, equipadas con cerradura y 2 estantes interiores extraíbles
- Rejilla lateral para herramientas (530 x 240 mm)
- Capacidad del cajón: 60 kg



2400 Kg PORTATA STATICA



CÓDIGO	Gavetas	Peso/kg	€/lista	€/PROMO
FG 162V/14L	14	184	3.300,00	1.899,00€
FG 162B/14L				
FG 162R/14L				
FG 162D/14L				



POSSIBILIDADE DE APLICAR DIFERENTES ACESSÓRIOS



TAMPO EM CONTRAPLACADO DE CHOUPÓ DE 18 MM

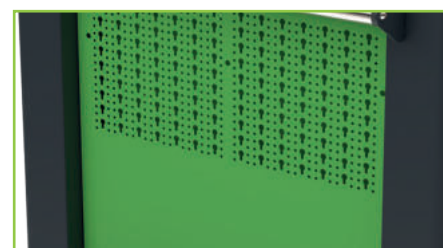

FUROS PARA GANCHOS DE FERRAMENTAS



CARRINHOS E BANCADAS DE TRABALHO



FG 120/CO1V

€/LISTA

~~2.690,00~~

PROMO
1.299,00€

CONFIGURAÇÃO MAXI STATION

Prateleira superior em aço com cobertura em policarbonato

Envernizamento mate enrugado

Pega em aço inoxidável

Gavetas de abertura total completo com tapetes anti-riscos e com divisórias

Coberturas de rodas dobráveis

4 rodas giratórias Ø 125mm com corpo em polipropileno e borracha vulcanizada (2 com travão)

Composto por:

FG 120V/7T - Módulo de gavetas fixo de 7 gavetas

FG 120V/A - Módulo fixo de uma porta

FG 120V/A - Módulo fixo de uma porta

Dimensão mm (LxPxH): 1540x460x1030



FG 120/CO1D



FG 120/CO1B



FG 120/CO1R



FG 120/CO2V

€/LISTA

~~2.690,00~~

PROMO
1.399,00€

CONFIGURAÇÃO MAXI STATION

Prateleira superior em aço com cobertura em policarbonato

Envernizamento mate enrugado

Pega em aço inoxidável

Gavetas de abertura total completo com tapetes anti-riscos e com divisórias

Coberturas de rodas dobráveis

4 rodas giratórias Ø 125mm com corpo em polipropileno e borracha vulcanizada (2 com travão)

Composto por:

FG 120V/7T - Módulo de gavetas fixo de 7 gavetas

FG 120V/A - Módulo fixo de uma porta

FG 120V/B - Módulo para rolo de papel, com gaveta de lixo

Dimensão mm (LxPxH): 1540x460x1030



FG 120/CO2D



FG 120/CO2B



FG 120/CO2R

FG 127V/A

€/LISTA
~~650,00~~

PROMO
379,00€

NEW

CARRINHO MULTIFUNCIONAL

Estrutura em chapa de aço com espessura 20/10
Pegas frontais e traseiras para máxima manobrabilidade
Superfície de apoio inclinada para portátil
Prateleira lateral para rato
2 prateleiras com altura regulável
5 ganchos para bobine de cabo em chapa de aço
3 compartimentos laterais
Suporte traseiro para rolo de papel
4 rodízios giratórios com piso de borracha resistente a riscos (Ø 75 mm, 2 com travões)
Peso: 25 Kg



CARRÉTEIS DE CABO DE 5 LADOS FEITOS DE CHAPA METÁLICA



SUPERFÍCIE DE APOIO INCLINADA COM COMPARTIMENTO LATERAL PARA O RATO



ALÇA TRASEIRA



FG 127V/B

€/LISTA
~~750,00~~

PROMO
429,00€

NEW

CARRINHO MULTIFUNCIONAL COM PORTA DE FECHO

Estrutura em chapa de aço com espessura 20/10
Pegas frontais e traseiras para máxima manobrabilidade
Superfície de trabalho inclinada, ideal para computadores portáteis
Prateleira lateral para rato
1 prateleira com altura regulável e 1 prateleira fixa
Compartimento com porta com fecho de segurança
5 ganchos para bobine de cabo em chapa de aço
3 compartimentos laterais
Suporte traseiro para rolo de papel
4 rodízios giratórios com piso de borracha resistente a riscos (Ø 75 mm, 2 com travões)
Peso: 28 Kg



ALÇAS DIANTEIRAS



COMPARTIMENTO COM PORTA QUE FECHA



SUPORTE TRASEIRO PARA PAPEL HIGIÉNICO



FG 101V/3G

€/LISTA
~~500,00~~

PROMO
249,00€

CARRINHO FG 101 COM 3 GAVETAS 26,5KG



2 PRATELEIRAS (ARMAZENAMENTO SUPERIOR E INFERIOR 680X440 MM)



POSSIBILIDADE DE INSERIR MÓDULOS DE HARDWARE



FG 108/B

€/LISTA
~~150,00~~

PROMO
89,00€

CARRINHO MULTI SERVIÇO UNIVERSAL PARA PEÇAS PEQUENAS E FERRAMENTAS DE TRABALHO



ESTRUTURA LATERAL EM ALUMÍNIO E PAINÉIS E ACESSÓRIOS EM ABS



EQUIPADO COM 16 TABULEIROS AMOVÍVEIS PARA PEÇAS PEQUENAS





CARRINHOS E BANCADAS DE TRABALHO

FG 101D/AS165

€/LISTA
~~1.684,00~~

PROMO
699,00€

CARRO DE FERRAMENTAS FG 101 COM 6 GAVETAS
COM UM SORTIDO DE 165 FERRAMENTAS EM MÓDULOS RÍGIDOS

SORTIDO 165 FERRAMENTAS



1º GAVETA



- FG 102/03G: Módulo rígido 14 llaves boca/ lunetas poligonales
- FG 102/17E: Módulo 65 herramientas de 1/4"
- FG 102/21E: Módulo chaves de caixas 6PT

2º GAVETA



- FG 102/48G: Módulo rígido 52 pontas de 10mm
- FG 102/VA1: Módulo rígido porta-objectos
- FG 102/65B: Módulo rígido 2 alicates ajustavel

3º GAVETA



- FG 102/45D: Módulo rígido 6 chaves de fenda sl e ph
- FG 102/45I: Módulo rígido 6 chaves de fenda torx
- FG 102/39D: Módulo rígido 3 alicates



SISTEMA DE ABERTURA POR BAIONETA

FG 101D/AS196

€/LISTA
~~2.134,00~~

PROMO
849,00€

**CARRO DE FERRAMENTAS FG 101 COM 7 GAVETAS
COM UN SORTIDO DE 196 FERRAMENTAS EN MÓDULO RÍGIDOS**

SORTIDO 196 FERRAMENTAS



1º GAVETA



- FG 102/03G: Módulo rígido 14 llaves boca/ lunetas poligonales
- FG 102/17E: Módulo 65 herramientas de 1/4"
- FG 102/21B: Módulo de chave hexagonal 1/2" 8-32mm + acessórios

2º GAVETA



- FG 102/39D: Módulo rígido 3 alicates
- FG 102/45I: Módulo rígido 6 chaves Torx
- FG 102/45D: Módulo rígido 6 chaves de fenda sl e ph

3º GAVETA



- FG 102/48G: Módulo rígido 52 puntas de 10mm
- FG 102/60D: Módulo de ferramenta de manutenção
- FG 102/23C: Módulo rígido chaves de caixas reforçadas

4º GAVETA



- FG 618/A8, A10, A13, A17, A19: Chaves T hexagonais com juntas





CARRINHOS E BANCADAS DE TRABALHO

FG 102V/AS205

€/LISTA
~~2.558,00~~

PROMO
999,00€

CARRO DE FERRAMENTAS FG 102 COM 6 GAVETAS,
COM UM SORTIDO DE 205 FERRAMENTAS EM MÓDULOS RÍGIDOS



CÓDIGO

FG 102D/AS205	FG 102B/AS205	FG 102R/AS205	FG 102V/AS205
---------------	---------------	---------------	---------------

SORTIDO 205 FERRAMENTAS

1º GAVETA



- FG 102/03G: Módulo rígido 14 llaves boca/ lunetas poligonales
- FG 102/17: Módulo 18 ferramentas de 1/4"
- FG 102/21B: Módulo de chave de caixa 1/2" 8-32mm + acessórios

2º GAVETA



- FG 102/21TX: Módulo rígido 44 ferramentas torx
- FG 102/21H: Módulo rígido chaves de ponta 1/2" hexagonais e xzn
- FG 102/39D: Módulo rígido 3 alicates

3º GAVETA



- FG 102/45F: Módulo rígido 6 chaves de fenda ph
- FG 102/45G: Módulo rígido 7 llaves de fenda sl
- FG 102/48G: Módulo rígido 52 pontas de 10mm

4º GAVETA

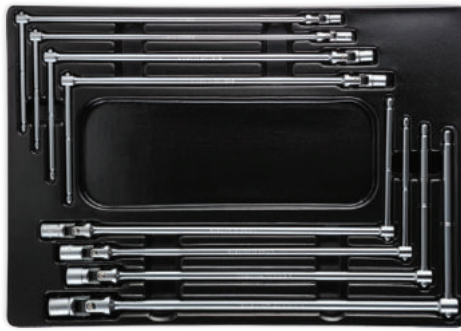

- FG 102/10C: Módulo de 8 chaves T de junta hexagonal 7-19mm



TAMPA
DE BORRACHA



FG 122V/AS170

€/LISTA
~~2.806,00~~

PROMO
1.199,00€

**CARRO DE FERRAMENTAS FG 122 COM 7 GAVETAS,
COM UM SORTIDO DE 170 FERRAMENTAS EM MÓDULOS RÍGIDOS**

NEW



CÓDIGO

FG 122V/AS170	FG 122D/AS170	FG 122B/AS170	FG 122R/AS170
---------------	---------------	---------------	---------------

SORTIDO 170 FERRAMENTAS

1º GAVETA



- FG 102/03G: Módulo rígido 14 laves boca/ lunetas poligonales
- FG 102/03L: Módulo 6 chaves de bocas
- FG 102/51H: Módulo 7 chaves hexagonais macho

2º GAVETA



- FG 102/17E: Módulo 65 ferramentas de 1/4"
- FG 102/21B: Módulo de chave de caixa 1/2" 8-32mm + acessórios
- FG 102/21H: Módulo rígido chaves de ponta 1/2" hexagonais e xzn

3º GAVETA



- FG 102/45F: Módulo rígido 6 chaves de fenda ph
- FG 102/45G: Módulo rígido 7 laves de fenda sl
- FG 102/56C: Módulo de ferramenta de impacto

4º GAVETA



- FG 102/42C: Módulo 4 grampos para anéis elásticos
- FG 102/39XT: Módulo 3 alicates
- FG 102/65B: Módulo rígido 2 alicates ajustavel

**4 RODAS DE BORRACHA
VULCANIZADA
Ø 125 MM
(2 FIXAS E 2 GIRATÓRIAS,
1 COM TRAVÃO)**





CARRINHOS E BANCADAS DE TRABALHO

FG 122V/AS212

€/LISTA
~~2.801,00~~

PROMO
1.199,00€

CARRO DE FERRAMENTAS FG 100 COM 7 GAVETAS,
COM UM SORTIDO DE 212 FERRAMENTAS EM MÓDULOS RÍGIDOS

NEW



CÓDIGO

FG 122V/AS212	FG 122D/AS212	FG 122B/AS212	FG 122R/AS212
---------------	---------------	---------------	---------------

SORTIDO 212 FERRAMENTAS

1º GAVETA



- FG 102/03G: Módulo rígido 14 laves boca/ lunetas poligonales
- FG 102/03L: Módulo 6 chaves de bocas
- FG 102/21B: Módulo de chave de caixa 1/2" 8-32mm + acessórios

2º GAVETA



- FG 102/17E: Módulo 65 ferramentas de 1/4"
- FG 102/19: Módulo 18 ferramentas 3/8"
- FG 102/45I: Módulo rígido 6 chaves Torx

3º GAVETA



- FG 102/39XT: Módulo 3 alicates
- FG 102/42C: Módulo rígido 4 alicates de freios
- FG 102/45E: Módulo rígido 8 chaves de fenda sl e ph

4º GAVETA



- FG 102/56C: Módulo rígido ferramentas de percussão
- FG 102/65B: Módulo rígido 2 alicates ajustavel
- FG 102/48G: Módulo rígido 52 pontas de 10mm

GAVETA
COM ABERTURA TOTAL



FG 100V/AS183

€/LISTA
~~2.685,00~~

PROMO
1.199,00€

**CARRO DE FERRAMENTAS FG 100 COM 7 GAVETAS,
COM UM SORTIDO DE 183 FERRAMENTAS EM MÓDULOS RÍGIDOS**



CÓDIGO

FG 100V/AS183	FG 100B/AS183	FG 100R/AS183	FG 100D/AS183	FG 100W/AS183
---------------	---------------	---------------	---------------	---------------

SORTIDO 183 FERRAMENTAS

1º GAVETA



- FG 102/03G: Módulo rígido 14 laves boca/ lunetas poligonales
- FG 102/03L: Módulo 6 chaves de bocas
- FG 102/21B: Módulo de chave de caixa 1/2" 8-32mm + acessórios

2º GAVETA



- FG 102/17: Módulo 18 ferramentas de 1/4"
- FG 102/48G: Módulo rígido 52 pontas de 10mm
- FG 102/21TX: Módulo rígido 44 ferramentas Torx

3º GAVETA



- FG 102/39XT: Módulo 3 alicates
- FG 102/45D: Módulo rígido 6 chaves de fenda sl e ph
- FG 102/45I: Módulo rígido 6 chaves Torx

4º GAVETA

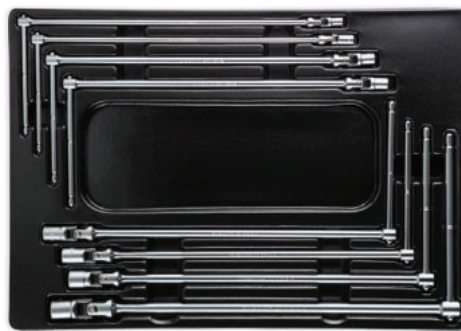

- FG 102/10C: Módulo de 8 chaves T de junta hexagonal 7-19mm

**PUXADOR DE AÇO
INTEGRADO**





CARRINHOS E BANCADAS DE TRABALHO

FG 100V/AS371

€/LISTA
~~3.795,80~~

PROMO
1.399,00€

CARRO DE FERRAMENTAS FG 100 COM 7 GAVETAS, COM UM SORTIDO DE 371 FERRAMENTAS EM MÓDULOS RÍGIDOS



CÓDIGO

FG 100V/AS371	FG 100B/AS371	FG 100R/AS371	FG 100D/AS371	FG 100W/AS371
---------------	---------------	---------------	---------------	---------------

SORTIDO 371 FERRAMENTAS

1° GAVETA



- FG 102/03G: Módulo rígido 14 laves boca/ lunetas poligonales
- FG 102/03L: Módulo 6 chaves de bocas
- FG 102/03E: Módulo rígido 8 chaves de boca

2° GAVETA



- FG 102/17E: Módulo 65 ferramentas de 1/4"
- FG 102/19: Módulo 18 ferramentas 3/8"
- FG 102/21B: Módulo de chave de caixa 1/2" 8-32mm + acessórios

3° GAVETA



- FG 102/21TX: Módulo rígido 44 ferramentas Torx
- FG 102/21H: Módulo rígido chaves de ponta 1/2" hexagonais e xzn
- FG 102/21R: Módulo chaves de pontas ribe

4° GAVETA



- FG 102/56C: Módulo rígido ferramentas de percussão
- FG 102/39XT: Módulo 3 alicates
- FG 102/42C: Módulo rígido 4 alicates de freios

5° GAVETA



- FG 102/45G: Módulo rígido 7 chaves de fenda ph
- FG 102/45F: Módulo rígido 6 chaves de fenda ph
- FG 102/45I: Módulo rígido 6 chaves Torx

6° GAVETA



- FG 102/48G: Módulo rígido 52 pontas de 10mm
- FG 102/65B: Módulo rígido 2 alicates ajustavel
- FG 102/23C: Módulo rígido chaves de caixas reforçadas
- FG 85/S31: Jogo de bits de 1/4" + adaptador de suporte de bits de 1/4" x 1/4"



FG 124V/AS257

€/LISTA
~~3.449,00~~

PROMO
1.499,00€

CARRO DE FERRAMENTAS FG 124 COM 7 GAVETAS, COM UM SORTIDO DE 257 FERRAMENTAS EM MÓDULOS RÍGIDOS

NEW



CÓDIGO

FG 124V/AS257	FG 124D/AS257	FG 124B/AS257	FG 124R/AS257
---------------	---------------	---------------	---------------

SORTIDO 257 FERRAMENTAS

1º GAVETA



- FG 102/03H: Módulo rígido 18 llaves combinadas
- FG 102/03E: Módulo rígido 8 llaves de doble tenedor
- FG 102/07C: Módulo 7 llaves dobles poligonales

2º GAVETA



- FG 102/17E: Módulo 65 herramientas de 1/4"
- FG 102/21TX: Módulo rígido 44 herramientas Torx
- FG 102/21B: Módulo de chave de caixa 1/2" 8-32mm + acessórios
- FG 102/21H: Módulo rígido chaves de ponta 1/2" hexagonais e xzn

4º GAVETA



- FG 102/42C: Módulo rígido 4 alicates de freios



- FG 102/65B: Módulo rígido 2 alicates ajustavel
- FG 102/10C: Módulo de 8 chaves T de junta hexagonal 7-19mm

CABO DE AÇO 20/10





CARRINHOS E BANCADAS DE TRABALHO

FG 102/03G

€/LISTA
~~149,00~~

PROMO
85,00€

MÓDULO 14 CHAVES BOCA/LUNETAS mm
FG 600/B6,7,8,9,10,11,12,13, 14,15,16,17,18,19mm

1/3



FG 102/07C

€/LISTA
~~98,00~~

PROMO
59,90€

MÓDULO 7 CHAVES DE LUNETA CURVADAS
FG 615/B6x7, 8x9, 10x11,12x13, 14x15, 16x17, 18x19mm

1/3



FG 102/03L

€/LISTA
~~145,00~~

PROMO
89,00€

MÓDULO 6 CHAVES BOCA/LUNETAS MM
FG 600/B21, 22, 24, 27, 30, 32 mm

1/3



FG 102/07D

€/LISTA
~~138,00~~

PROMO
83,90€

MÓDULO 5 CHAVES DE LUNETA CURVADAS
FG 615/B20x22, 21x23, 24x27, 25x28, 30x32mm

1/3



FG 102/03H

€/LISTA
~~250,00~~

PROMO
149,00€

MÓDULO 18 CHAVES BOCA/LUNETAS MM
FG 600/B6,7,8,10,11,12,13,14,16,17,18,19, 21, 22, 24, 27, 30, 32mm

2/3



FG 102/08C

€/LISTA
~~245,00~~

PROMO
155,00€

MÓDULO 11 CHAVES COM ROQUETE
FG 605/B8, 10, 11, 12, 13, 14, 15, 16, 17, 18, 19mm

1/3



FG 102/10C

€/LISTA
~~340,00~~

PROMO
209,00€

MÓDULO 8 CHAVES EM T HEXAGONAIS
FG 618/A7, 8, 10, 11, 13, 14, 17, 19 mm

1/1



FG 102/03E

€/LISTA
~~85,00~~

PROMO
52,90€

MÓDULO 8 CHAVES DE BOCAS
FG 602/B6x7, 8x9, 10x11, 12x13, 14x15, 16x17, 18x19, 20x22 mm + FG 139C/FS

1/3



FG 102/03F

€/LISTA
~~100,00~~

PROMO
63,90€

MÓDULO 5 CHAVES DE BOCAS
FG 602/B21x23, 24x26, 25x28, 27x29, 30x32 mm

1/3



FG 102/13C

€/LISTA
~~190,00~~

PROMO
119,00€

MÓDULO 8 CHAVES DE CACHIMBO
FG 613/A6,7,8,10,11,12,13,14,17,19mm

1/3



FG 102/17

€/LISTA
~~135,00~~

PROMO
79,90€

MÓDULO CHAVES DE CAIXAS 6PT

FG 615/B6x7, 8x9, 10x11,12x13, 14x15, 16x17, 18x19mm



MÓDULO CHAVES DE CAIXAS 6PT
10-32mm

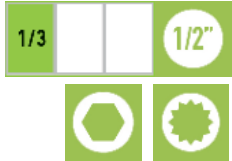

CÓDIGO	LIGAÇÃO	€/LISTA	€/PROMO
FG 102/21E	Hexagonal	170,00	99,00€
FG 102/21D	Poligonal	170,00	99,00€

FG 102/17E

€/LISTA
~~275,00~~

PROMO
159,00€

MÓDULO CHAVES DE CAIXAS 6PT

FG 605/B8, 10, 11, 12, 13, 14, 15, 16, 17, 18, 19mm



FG 102/21TX

€/LISTA
~~245,00~~

PROMO
139,00€

MÓDULO FERRAMENTAS TORX



FG 102/19

€/LISTA
~~200,00~~

PROMO
119,00€

MÓDULO CHAVES DE CAIXAS 6PT

8-23mm Hexagonal



FG 102/21H

€/LISTA
~~210,00~~

PROMO
129,00€

MÓDULO CHAVES DE PONTAS

FG 150/H2-H8, FG 150L/H2-H8, FG 150/M5-M16, FG 150L/M5-M16



FG 102/19B

€/LISTA
~~200,00~~

PROMO
119,00€

MÓDULO CHAVES DE CAIXAS 6PT

8- 23mm Poligonal



FG 102/21R

€/LISTA
~~230,00~~

PROMO
139,00€

MÓDULO CHAVES DE PONTAS RIBE

FG 150/R4-R14, FG 150L/R4-R14, FG 150/R4-R14, FG 150L/R4-R14

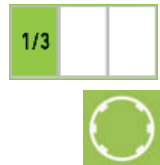

MÓDULO CHAVES DE CAIXAS 6PT

10-32mm



MÓDULO CHAVES DE CAIXAS 6PT
34-50mm



CÓDIGO	LIGAÇÃO	€/LISTA	€/PROMO
FG 102/21B	Hexagonal	245,00	139,00€
FG 102/21C	Poligonal	255,00	139,00€

CÓDIGO	LIGAÇÃO	€/LISTA	€/PROMO
FG 102/25	Hexagonal	395,00	239,00€
FG 102/25B	Poligonal	395,00	239,00€



CARRINHOS E BANCADAS DE TRABALHO

FG 102/23C

€/LISTA
~~145,50~~

PROMO
89,00€

MÓDULO CHAVES DE CAIXAS DE IMPACTO

FG 628/C10,11,12,13,14,16,17,18,19,21,22,23,24mm + FG 628/PR125



FG 102/45D

€/LISTA
~~47,00~~

PROMO
28,90€

MÓDULO DE 6 CHAVES DE FENDA

FG 22/3x100, 4x125, 5.5x150, 6.5x150, FG 22/PH1x80,



FG 102/51H

€/LISTA
~~130,00~~

PROMO
81,90€

MÓDULO DE 7 TECLAS HEXAGONAL

FG 621/H2, 2.5, 3, 4, 5, 6, 8mm



FG 102/45E

€/LISTA
~~57,00~~

PROMO
34,90€

MÓDULO DE 8 CHAVES DE FENDA

3x100, 4x125, 5.5x150, 6.5x150, 6.5x38, PH1x80, PH2x150, PH2x38



FG 102/39XT

€/LISTA
~~102,00~~

PROMO
59,90€

MÓDULO 3 ALICATES

FG 59/XT180 - FG 61/XT160 - FG 63TXT160



FG 102/45F

€/LISTA
~~54,00~~

PROMO
33,90€

MÓDULO DE 6 CHAVES DE FENDA

PH0x60, PH1x150, PH2x100, PH2x150, PH3x150, PH2x38



FG 102/39D

€/LISTA
~~75,00~~

PROMO
46,90€

MÓDULO 3 ALICATES

FG 59PV/180, FG 61PV/160, FG 63PV/160



FG 102/45G

€/LISTA
~~54,00~~

PROMO
33,90€

MÓDULO DE 7 CHAVES DE FENDA

2.5x60, 3x100, 3.5x100, 4x125, 5.5x150, 5.5x100, 6.5x150



MÓDULO 4 ALICATES DE FREIOS



FG 102/45U

€/LISTA
~~98,00~~

PROMO
59,90€

MÓDULO DE 12 CHAVES DE FENDA



CÓDIGO	CAPACIDADE	€/LISTA	€/PROMO
FG 102/41C	8-25mm	98,00	59,90€
FG 102/42C	19-60mm	110,00	65,00€

MÓDULO DE 6 CHAVES DE FENDA
TX10, TX15, TX20, TX25, TX27, TX30



1/3



FG 102/56C

€/LISTA
~~125,00~~

PROMO
79,90€

MÓDULO FERRAMENTAS DE PERCUSSÃO
FG 132/500, FG 136/40, FG 126/SN1, FG 126/SN3



1/3

CÓDIGO	LIGAÇÃO	€/LISTA	€/PROMO
FG 102/45I	Torx	66,00	39,90€
FG 102/45L	Torx perforado	67,00	41,90€

FG 102/45T

€/LISTA
~~78,00~~

PROMO
39,90€

MÓDULO DE 6 CHAVES DE FENDA
FG 22/FX6, FX7, FX8, FX10, FX13



1/3



FG 102/60D

€/LISTA
~~58,00~~

PROMO
36,90€

MÓDULO DE FERRAMENTA DE MANUTENÇÃO
FG 44/MT5, FG 50/AR, FG 48/LG, FG 79/SP4, FG 497/OP1



1/3

FG 102/48G

€/LISTA
~~120,00~~

PROMO
73,90€

MÓDULO DE PONTAS DE 10MM



1/3



FG 102/62B

€/LISTA
~~95,00~~

PROMO
59,90€

MÓDULO 5 LIMAS MEIO-MURÇAS
FG 80/8AR, FG 80/8AM, FG 80/8AP, FG 80/8AT, FG 80/8AQ



1/3

FG 102/50F

€/LISTA
~~76,00~~

PROMO
46,90€

MÓDULO DE CHAVES MACHOS HEXAGONAIS
FG 142/2, 2.5, 3, 4, 5, 6



1/3



FG 102/65B

€/LISTA
~~66,00~~

PROMO
41,90€

MÓDULO 2 ALICATES
FG 58/B240, FG 69/CJ250FG 80/8AR, FG 80/8AM, FG 80/8AP, FG 80/8AT, FG 80/8AQ



1/3

FG 102/50G

€/LISTA
~~76,00~~

PROMO
46,90€

MÓDULO DE CHAVES MACHOS TORX
FG 143/TX10, TX15, TX20, TX25, TX27, TX30



1/3



FG 102/VA1

€/LISTA
~~15,00~~

PROMO
8,90€

MÓDULO PORTA OBJECTOS



1/3



CARRINHOS E BANCADAS DE TRABALHO

FG 122V/AS217

€ LISTA
~~2.604,50~~

PROMO
1.099,00€

CARRO DE FERRAMENTAS FG 122 DE 6 GAVETAS
COM 217 FERRAMENTAS EM MÓDULOS DE BORRACHA



CÓDIGO

FG 122V/AS217	FG 122D/AS217	FG 122B/AS217	FG 122R/AS217
---------------	---------------	---------------	---------------

SORTIDO 217 FERRAMENTAS

1º GAVETA

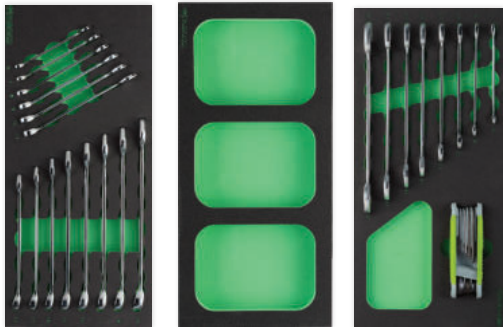

- FG 100/03G: Módulo rígido 14 laves boca/ lunetas poligonales
- FG 100/VA1: Módulo rígido porta-objects
- FG 100/03E: Módulo 8 chaves de bocas + jogo de 9 chaves sextavadas

2º GAVETA



- FG 100/17: Módulo 18 ferramentas de 1/4"
- FG 100/19: Módulo chaves de caixas 6PT
- FG 100/21B: Módulo de chave de caixa 1/2" 8-32mm + acessórios

3º GAVETA



- FG 100/39XT: Módulo 3 alicates
- FG 100/48E: Módulo 98 inserções de 1/4" + 2 suportes de inserção e espaço vazio
- FG 100/65B: Módulo de alicates

4º GAVETA

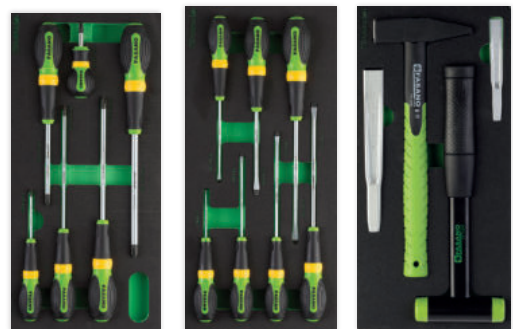

- FG 100/45F: Módulo 6 chaves de fenda PH
- FG 100/45G: Módulo de 7 chaves de fenda
- FG 100/56C: Módulo de percussão



CABEDAL DE BORRACHA
COM ACABAMENTO
EM CARBONO 3D



FG 100V/AS224

€/LISTA
2.878,00

PROMO
1.199,00€

**CARRO DE FERRAMENTAS FG 100 DE 7 GAVETAS
COM 224 FERRAMENTAS EM MÓDULOS DE BORRACHA**



CÓDIGO

FG 100V/AS224	FG 100B/AS224	FG 100R/AS224	FG 100D/AS224	FG 100W/AS224
---------------	---------------	---------------	---------------	---------------

SORTIDO 224 FERRAMENTAS

1º GAVETA



- FG 100/03G: Módulo rígido 14 llaves boca/ lunetas poligonales
- FG 100/17E: Módulo 65 herramientas de 1/4"
- FG 100/21B: Módulo de chave de caixa 1/2" 8-32mm + acessórios

2º GAVETA

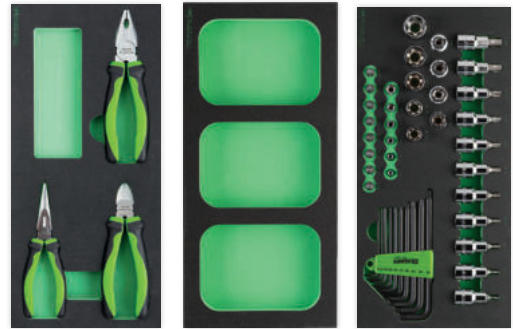

- FG 100/39XT: Módulo 3 alicates
- FG 100/VA1: Módulo rígido porta-objectos
- FG 100/21TX: Módulo rígido 44 ferramentas torx

3º GAVETA



- FG 100/45I: Módulo 6 chaves de fenda Torx
- FG 100/45D: Módulo 6 chaves de fenda SL e PH
- FG 100/48G: Módulo 52 puntas de 10mm

4º GAVETA

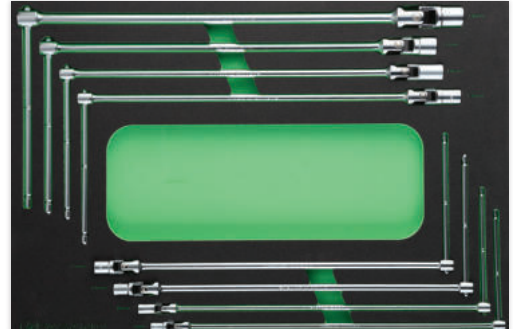

- FG 100/10C: Módulo 8 chaves em T hexagonais 7-19mm



**PRATELEIRA SUPERIOR
EM ABS**





CARRINHOS E BANCADAS DE TRABALHO

FG 122V/AS413

€/LISTA
~~4.862,80~~

PROMO
1.599,00€

CARRO DE FERRAMENTAS FG 122 DE 7 GAVETAS
COM 413 FERRAMENTAS EM MÓDULOS DE BORRACHA



CODICE

FG 122V/AS413	FG 122D/AS413	FG 122B/AS413	FG 122R/AS413
---------------	---------------	---------------	---------------

SORTIDO 413 FERRAMENTAS

1° GAVETA

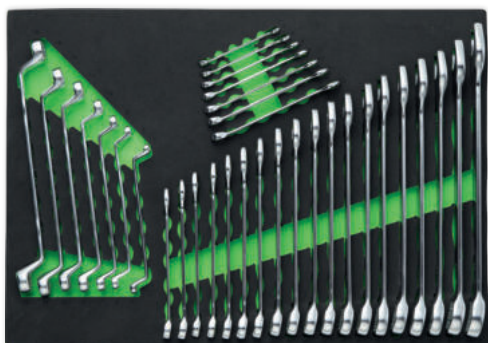

-FG 100/03M: Módulo de chaves combinadas poligonais e dupla curvatura

2° GAVETA



-FG 100/21F: Módulo 1/4", 1/2", 3/8" chaves de caixa hexagonais e acessórios

3° GAVETA



-FG 100/81G: Módulo chaves de ponta 1/4" e 1/2"

4° GAVETA

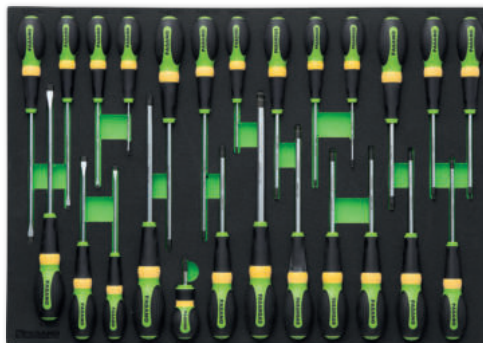

-FG 100/45R: Módulo chaves parafusos de fenda, ph, hex, esféricas y torx

5° GAVETA



-FG 100/39E: Módulo de alicates y puntas

MÓDULOS DE BORRACHA GAVETA COMPLETA



FG 100V/AS230

€/LISTA
~~3.571,50~~

PROMO
1.499,00€

**CARRO DE FERRAMENTAS FG 100 DE 7 GAVETAS
COM 230 FERRAMENTAS EM MÓDULOS DE BORRACHA**



CÓDIGO

FG 100V/AS230	FG 100B/AS230	FG 100R/AS230	FG 100D/AS230	FG 100W/AS230
---------------	---------------	---------------	---------------	---------------

SORTIDO 230 FERRAMENTAS

1° GAVETA



- FG 100/03G: Módulo rígido 14 llaves boca/ lunetas poligonales
- FG 100/03L: Módulo 6 chaves boca/lunetas mm
- FG 100/03E: Módulo 8 chaves de bocas + jogo de 9 chaves sextavadas

2° GAVETA

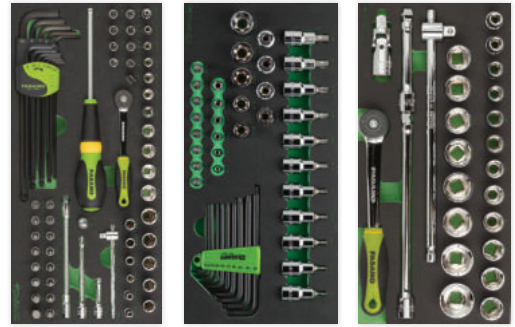

- FG 100/17E: Módulo 65 ferramentas de 1/4"
- FG 100/21TX: Módulo rígido 44 ferramentas torx
- FG 100/21B: Módulo de chave de caixa 1/2" 8-32mm + acessórios

3° GAVETA



- FG 100/81F: Módulo de inserção sextavado e XZN 1/2"
- FG 100/65B: Módulo de alicates
- FG 100/42C: Módulo 4 alicates de freios

4° GAVETA



- FG 100/39XT: Módulo 3 alicates
- FG 100/45D: Módulo 6 chaves de fenda SL e PH
- FG 100/45I: Módulo 6 chaves de fenda Torx

5° GAVETA

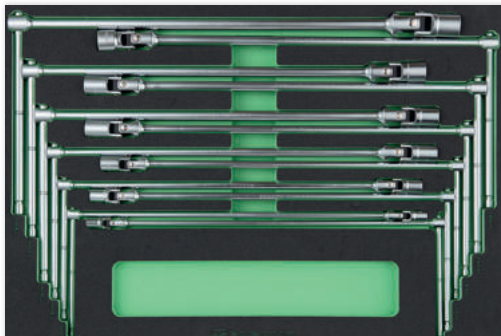

- FG 100/10D: Módulo 12 chaves em t hexagonais 7-19mm



CARRINHOS E BANCADAS DE TRABALHO

FG 122V/AS402

€/LISTA
~~4.933,00~~

PROMO
1.599,00€

CARRO DE FERRAMENTAS FG 122 DE 7 GAVETAS
COM 402 FERRAMENTAS EM MÓDULOS DE BORRACHA



CÓDIGO

FG 122V/AS402	FG 122D/AS402	FG 122B/AS402	FG 122R/AS402
---------------	---------------	---------------	---------------

SORTIDO 402 FERRAMENTAS

1° GAVETA

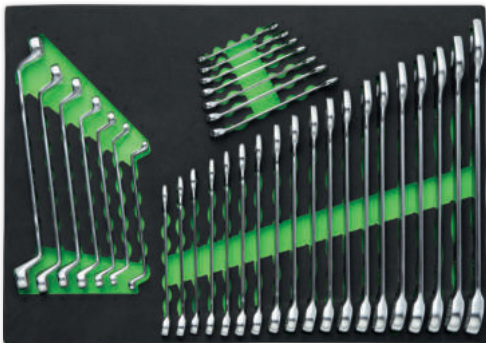

FG 100/03M: Módulo de chaves combinadas poligonais e dupla curvatura

2° GAVETA



FG 100/21F: Módulo 1/4", 1/2", 3/8" chaves de caixa hexagonais e acessórios

3° GAVETA



FG 100/81G: Módulo chaves de ponta 1/4" e 1/2"

4° GAVETA



FG 100/39F: Módulo chaves para parafusos, alicates, y pontas

5° GAVETA

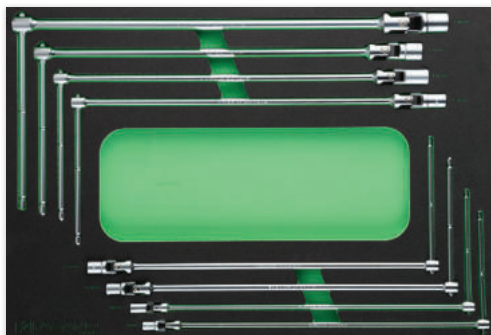

FG 100/10C: Módulo 8 chaves em T hexagonais 7-19mm



FG 100VD/AS355

€LISTA
4.203,80

PROMO
1.599,00€

CARRO DE FERRAMENTAS FG 100 BI COLOR DE 7 GAVETAS COM 355 FERRAMENTAS EM MÓDULOS DE BORRACHA



FG 100VD/AS355 FG 100VW/AS355 FG 100BW/AS355 FG 100RY/AS355 FG 100CW/AS355 FG 100MA/AS355 FG 100RB/AS355
FG 100DP/AS355 FG 100DW/AS355 FG 100BY/AS355 FG 100BD/AS355 FG 100RD/AS355 FG 100GW/AS355 FG 100RW/AS355



SORTIDO 355 FERRAMENTAS

1º GAVETA

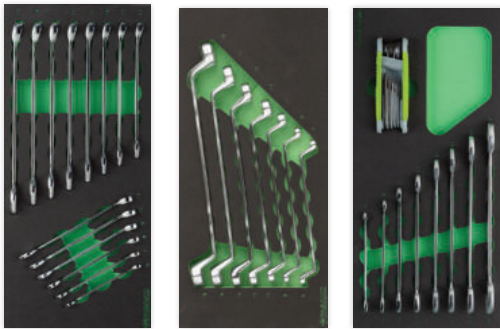

- FG 100/03G: Módulo rígido 14 laves boca/ lunetas poligonales
- FG 100/07C: Módulo 7 chaves de luneta com curvatura
- FG 100/03E: Módulo 8 chaves de bocas + jogo de 9 chaves sextavadas

2º GAVETA



- FG 100/17E: Módulo 65 ferramentas de 1/4"
- FG 100/19: Módulo chaves de caixas 6PT
- FG 100/21B: Módulo de chave de caixa 1/2" 8-32mm + acessórios

3º GAVETA



- FG 100/21TX: Módulo rígido 44 ferramentas torx
- FG 100/81F: Módulo de inserção sextavado e XZN 1/2"
- FG 100/82B: Módulo chaves de pontas RIBE

4º GAVETA

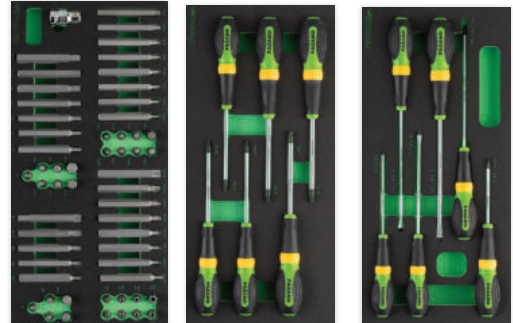

- FG 100/48G: Módulo 52 pontas de 10mm
- FG 100/45I: Módulo 6 chaves de fenda Torx
- FG 100/45D: Módulo 6 chaves de fenda SL e PH

5º GAVETA



- FG 100/65B: Módulo 2 alicates
- FG 100/39XT: Módulo 3 alicates
- FG 100/42C: Módulo 4 alicates de freios

6º GAVETA

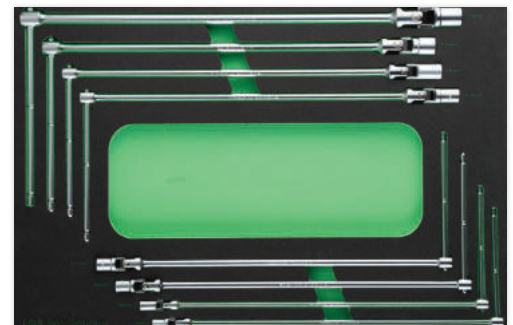

- FG 100/10C: Módulo de 8 chaves T de junta hexagonal 7-19mm
- FG 85/S31: Jogo de bits de 1/4" + adaptador de suporte de bits de 1/4" x 1/4"



CARRINHOS E BANCADAS DE TRABALHO

FG 124V/AS322

€/LISTA
3.926,50

PROMO
1.599,00€

**CARRO DE FERRAMENTAS FG 124 DE 7 GAVETAS
COM 322 FERRAMENTAS EM MÓDULOS DE BORRACHA**



CÓDIGO

FG 124V/AS322	FG 124D/AS322	FG 124B/AS322	FG 124R/AS322
---------------	---------------	---------------	---------------

SORTIDO 322 FERRAMENTAS

1º GAVETA



- FG 100/03G: Módulo rígido 14 laves boca/ lunetas poligonales
- FG 100/03L: Módulo 6 chaves boca/lunetas mm
- FG 100/VA4: Módulo porta objetos
- FG 100/21H: Módulo chaves de caixas 6PT

2º GAVETA

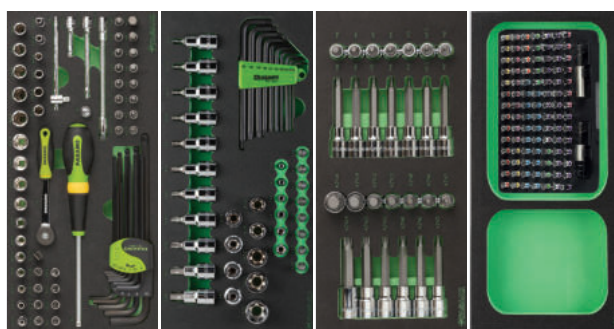

- FG 100/17E: Módulo 65 ferramentas de 1/4"
- FG 100/21TX: Módulo rígido 44 ferramentas torx
- FG 100/81F: Módulo de inserção sextavado e XZN 1/2"
- FG 100/48E: Módulo 98 inserções de 1/4" + 2 suportes de inserção e espaço vazio

3º GAVETA



- FG 100/42C: Módulo 4 alicates de freios
- FG 100/39XT: Módulo 3 alicates
- FG 100/45D: Módulo 6 chaves de fenda SL e PH
- FG 100/45I: Módulo 6 chaves de fenda Torx

4º GAVETA

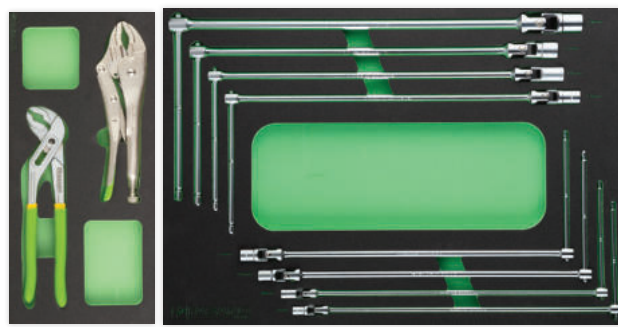

- FG 100/65B: Módulo de alicates
- FG 100/10C: Módulo 8 chaves em T hexagonais 7-19mm



**PUXADOR DE AÇO
INOXIDÁVEL**

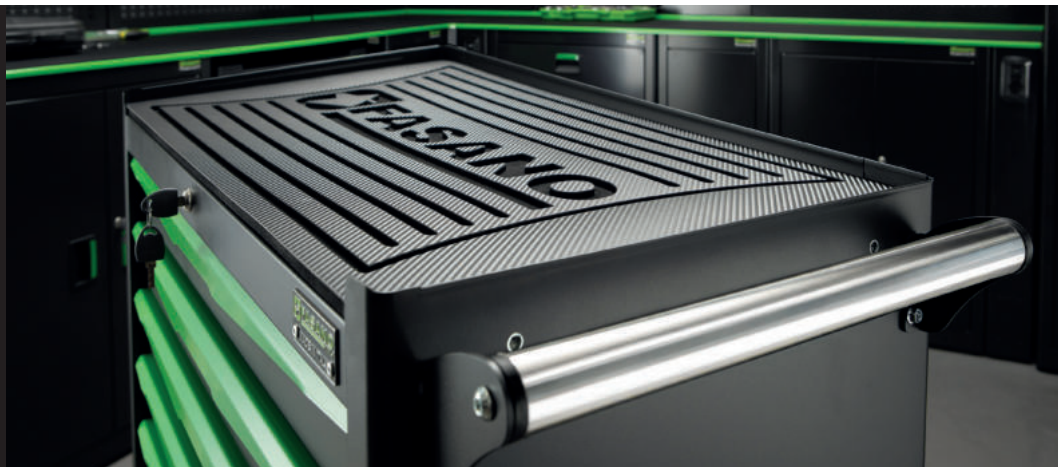

FG 162V/AS308

€/LISTA
~~6.163,50~~

PROMO
2.799,00€

CARRO DE FERRAMENTAS FG 162 DE 14 GAVETAS COM 308 FERRAMENTAS EM MÓDULOS DE BORRACHA



CÓDIGO

FG 162V/AS308	FG 162B/AS308	FG 162R/AS308	FG 162D/AS308
---------------	---------------	---------------	---------------

SORTIDO 308 FERRAMENTAS

1º GAVETA

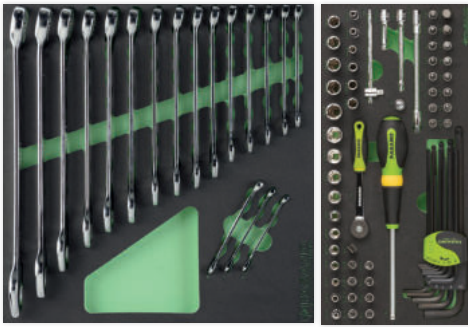

- FG 100/03H: Módulo 18 chaves boca/lunetas mm
- FG 100/17E: Módulo 65 ferramentas de 1/4"

2º GAVETA



- FG 100/21B: Módulo de chave de caixa 1/2" 8-32mm + acessórios
- FG 100/21TX: Módulo rígido 44 ferramentas torx
- FG 100/19: Módulo chaves de caixas 6PT

3º GAVETA

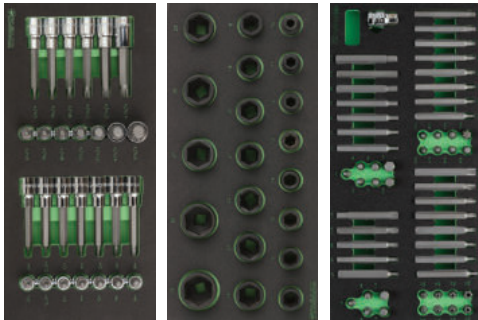

- FG 100/81F: Módulo de inserção sextavado e XZN 1/2"
- FG 100/23C: Módulo 20 chaves de cano reforçada
- FG 100/48G: Módulo 52 pontas de 10mm

4º GAVETA

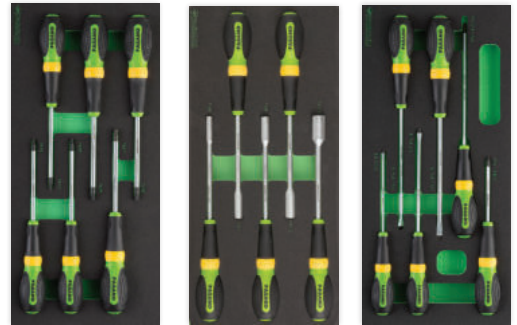

- FG 100/45I: Módulo 6 chaves de fenda Torx
- FG 100/45T: Módulo 5 chaves de fendas sextavadas
- FG 100/45D: Módulo 6 chaves de fenda SL e PH

5º GAVETA



- FG 100/65B: Módulo 3 alicates
- FG 100/39XT: Módulo 3 alicates
- FG 100/42C: Módulo 4 alicates de freios

6º GAVETA

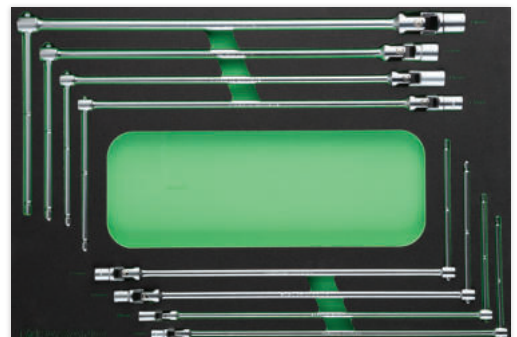

- FG 100/10C: Módulo 8 chaves em T hexagonais 7-19mm



CARRINHOS E BANCADAS DE TRABALHO

MÓDULO 14 CHAVES BOCA/LUNETAS MM FG 600/B6,7,8,9,10,11,12,13,14,15,16,17,18,19mm

1/3



CÓDIGO	CHAVE	€/LISTA	€/PROMO
FG 100/03G	FG 600/B	160,00	89,90€
FG 100/03G-A	FG 600/A	170,00	99,90€

MÓDULO 6 CHAVES BOCA/LUNETAS MM FG 600/B21,22,24,27,30,32mm

1/3



CÓDIGO	CHAVE	€/LISTA	€/PROMO
FG 100/03L	FG 600/B	158,00	89,90€
FG 100/03L-A	FG 600/A	168,00	105,00€

MÓDULO 18 CHAVES BOCA/LUNETAS MM FG 600/B6,7,8,10,11,12,13,14,16,17,18,19,21,22,24,27,30,32mm

2/3



CÓDIGO	CHAVE	€/LISTA	€/PROMO
FG 100/03H	FG 600/B	310,00	179,00€
FG 100/03H-A	FG 600/A	320,00	189,00€

FG 100/03E

€/LISTA

~~98,00~~

PROMO
61,90€

MÓDULO 8 CHAVES DE BOCAS FG 602/B6x7,8x9,10x11,12x13,14x15,16x17,18x19,20x22 mm + FG 139C/FS

1/3



FG 100/03F

€/LISTA

~~110,00~~

PROMO
69,90€

MÓDULO 5 CHAVES DE BOCAS FG 602/B21x23,24x26,25x28,27x29,30x32 mm

1/3



FG 100/07C

€/LISTA

~~112,00~~

PROMO
65,90€

MÓDULO 7 CHAVES DE LUNETA CURVADAS FG 615/B6x7,8x9,10x11,12x13,14x15,16x17,18x19mm

1/3

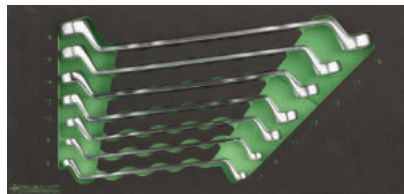

FG 100/07D

€/LISTA

~~160,00~~

PROMO
99,00€

MÓDULO 5 CHAVES DE LUNETA CURVADAS FG 615/B20x22,21x23,24x27,25x28,30x32mm

1/3



FG 100/08C

€/LISTA

~~265,00~~

PROMO
165,00€

MÓDULO 8 CHAVES COM ROQUETE FG 605/B8,10,11,12,13,14,15,16,17,18,19mm

1/3



FG 100/10C

€/LISTA

~~390,00~~

PROMO
249,00€

MÓDULO 8 CHAVES EM T HEXAGONAIS FG 618/A7,8,10,11,13,14,17,19 mm

1/1

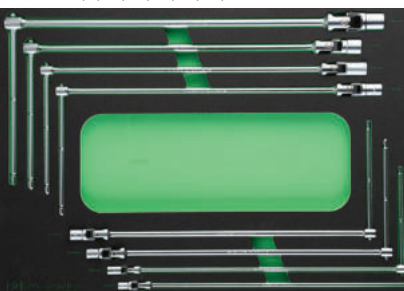

FG 100/10D

€/LISTA

~~570,00~~

PROMO
359,00€

MÓDULO 12 CHAVES EM T HEXAGONAIS
FG 618/A7, 8,10,11,12,13,14,15,16,17,18,19 mm

1/1



MÓDULO CHAVES DE CAIXAS 6PT
10-32mm

1/3

1/2"



CÓDIGO	LIGAÇÃO	€/LISTA	€/PROMO
FG 100/21B	Hexagonal	250,00	149,00€
FG 100/21C	Poligonal	250,00	149,00€

MÓDULO CHAVES DE CAIXAS 6PT
10-32mm

1/3

1/2"

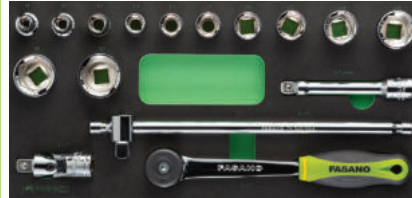

CÓDIGO	LIGAÇÃO	€/LISTA	€/PROMO
FG 100/21M	Hexagonal	170,00	99,00€
FG 100/21D	Poligonal	170,00	99,00€

FG 100/17

€/LISTA

~~145,00~~

PROMO
79,90€

MÓDULO CHAVES DE CAIXAS 6PT
4-14mm

1/3

1/4"



FG 100/21H

€/LISTA

~~440,00~~

PROMO
269,00€

MÓDULO CHAVES DE CAIXAS 6PT
Tomadas curtas: 8-32 mm (exceto 25 mm)
Tomadas longas: 10-32 mm

2/3

1/2"

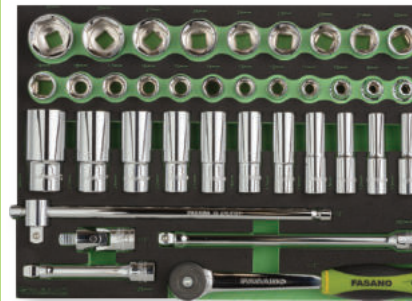

FG 100/17E

€/LISTA

~~290,00~~

PROMO
169,00€

MÓDULO CHAVES DE CAIXAS 6PT

1/3

1/4"



FG 100/18

€/LISTA

~~295,00~~

PROMO
179,00€

MÓDULO CHAVES DE CAIXAS 6PT
9-19mm

1/3

3/8"



FG 100/21TX

€/LISTA

~~270,00~~

PROMO
159,00€

MÓDULO 44 FERRAMENTAS TORX

1/3

1/4"

1/2"

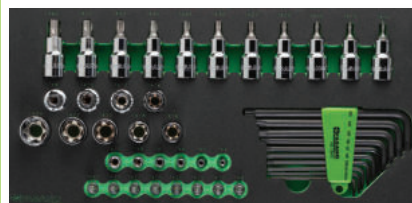

FG 100/19

€/LISTA

~~240,00~~

PROMO
139,00€

MÓDULO CHAVES DE CAIXAS 6PT
9-19mm

1/3

3/8"



FG 100/81F

€/LISTA

~~200,00~~

PROMO
119,00€

MÓDULO CHAVES DE PONTAS
FG 150/H2-H8, FG 150L/H2-H8, FG 150/M5-M16,
FG 150L/M5-M14

1/3

1/4"

1/2"

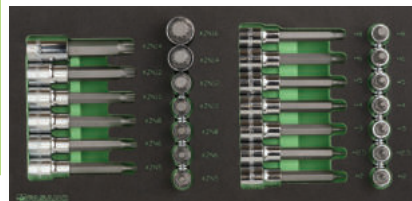



CARRINHOS E BANCADAS DE TRABALHO

FG 100/23C

€/LISTA

~~220,00~~**PROMO**
129,00€

MÓDULO CHAVES DE CAIXAS DE IMPACTO
FG 628/C10, 11, 12, 13, 14, 15, 16, 17, 18, 19, 21,
22, 23, 24, 25, 26, 27, 30, 32mm

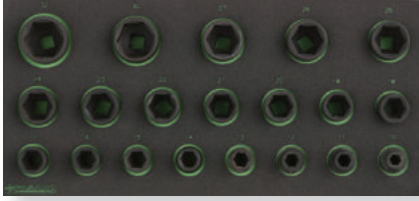

1/3

1/2"



FG 100/65C

€/LISTA

~~145,00~~**PROMO**
92,50€

MÓDULO DE ALICATES
FG 70/CJ250 - FG 58/A240 - FG 49/HE250



1/3

FG 100/23B

€/LISTA

~~360,00~~**PROMO**
219,00€

MÓDULO CHAVES DE CAIXAS DE IMPACTO
FG 628/L10, 11, 12, 13, 14, 15, 16, 17, 18, 19, 21,
22, 23, 24, 25, 27, 29, 30, 32mm



1/3

1/2"



FG 100/45D

€/LISTA

~~69,00~~**PROMO**
39,90€

MÓDULO DE 6 CHAVES DE FENDA
FG 22/3x100, 4x125, 5.5x200, 6.5x150,
FG 22/PH1x80, PH2x150



1/3



FG 100/39XT

€/LISTA

~~110,00~~**PROMO**
69,00€

MÓDULO 3 ALICATES
FG 59/XT180 - FG 61/XT160 - FG 63/XT160

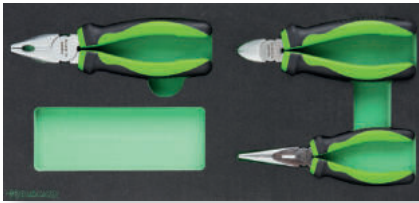

1/3

FG 100/45E

€/LISTA

~~84,00~~**PROMO**
49,90€

MÓDULO DE 8 CHAVES DE FENDA
3x100, 4x125, 5.5x150, 6.5x150, 6.5x38, PH1x80,
PH2x150, PH2x38



1/3



MÓDULO 4 ALICATES DE FREIOS

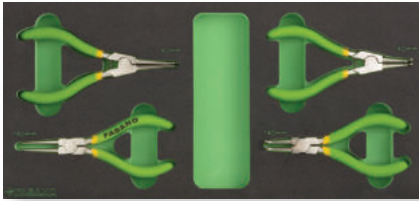

1/3

FG 100/45F

€/LISTA

~~70,00~~**PROMO**
42,90€

MÓDULO DE 6 CHAVES DE FENDA
PH0x60, PH1x150, PH2x100, PH2x150, PH3x150, PH2x38



1/3



CÓDIGO	CAPACIDADE	€/LISTA	€/PROMO
FG 100/41C	8-25mm	113,00	69,00€
FG 100/42C	19-60mm	118,00	73,90€

FG 100/65B

€/LISTA

~~93,50~~**PROMO**
55,90€

MÓDULO DE ALICATES
FG 58/B240, FG 69/CJ250



1/3

FG 100/45G

€/LISTA

~~70,00~~**PROMO**
42,90€

MÓDULO DE 7 CHAVES DE FENDA
2.5x60, 3x100, 3.5x100, 4x125, 5.5x150, 5.5x100, 6.5x150



1/3



FG 100/45I

€/LISTA
~~85,00~~

PROMO
49,90€

MÓDULO DE 6 CHAVES DE FENDA
TX10, TX15, TX20, TX25, TX27, TX30



FG 100/50F

€/LISTA
~~90,00~~

PROMO
54,90€

MÓDULO DE CHAVES MACHOS HEXAGONAIS
FG 142/2, 2.5, 3, 4, 5, 6

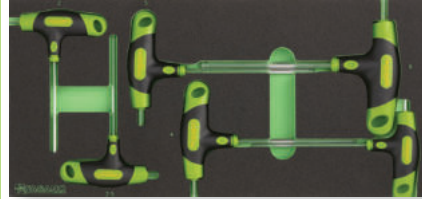

FG 100/45T

€/LISTA
~~88,00~~

PROMO
53,90€

MÓDULO DE 5 CHAVES DE FENDA
FG 22/FX6, FX7, FX8, FX10, FX13

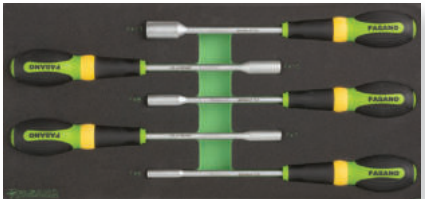

FG 100/50G

€/LISTA
~~90,00~~

PROMO
54,90€

MÓDULO DE CHAVES MACHOS TORX
FG 143/TX10, TX15, TX20, TX25, TX27, TX30

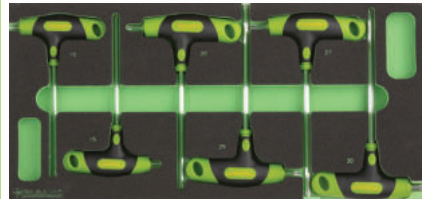

FG 100/45H

€/LISTA
~~80,00~~

PROMO
49,00€

MÓDULO DE 5 CHAVES DE FENDA
FG 22/2.5x300, 4x400, 5.5x400, FG 22/PH1x400, PH2x400

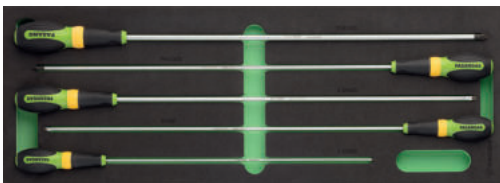

FG 100/56C

€/LISTA
~~142,00~~

PROMO
89,90€

MÓDULO DE PERCUSSÃO
FG 132/500, FG 136/30 - FG 126/SN1, FG 126/SN3



FG 100/48G

€/LISTA
~~130,00~~

PROMO
82,90€

MÓDULO DE PONTAS DE 10MM

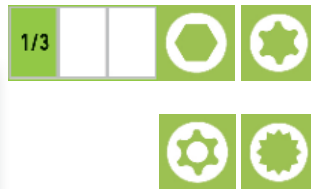
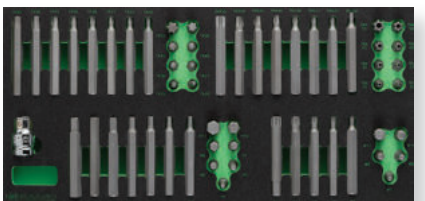

FG 100/54

€/LISTA
~~188,00~~

PROMO
119,00€

MÓDULO FERRAMENTAS DE MEDIÇÃO
FG 95/CA, FG 188/2, FG 95/M1, FG 81/PT1, FG 44/MT5



FG 100/51H

€/LISTA
~~145,00~~

PROMO
89,90€

MÓDULO DE CHAVES MACHOS HEXAGONAIS
FG 621/H2, 2.5, 3, 4, 5, 6, 8mm



FG 100/76C

€/LISTA
~~275,00~~

PROMO
169,00€

OS PLUGUES DO FILTRO DE ÓLEO E AS CHAVES SE FORMAM
FG 176/F01 - FG 176/RE - FG 175/S15





MÓDULOS DE BORRACHA COM GAVETA COMPLETA

IMPRESSÃO BI-COLOR

CÓDIGO DE FERRAMENTA GRAVADO A LASER, PARA QUE POSSA ENCONTRAR TUDO O QUE PRECISA NUM RELANCE E POUPAR TEMPO



FG 100/03M

MÓDULO DE CHAVES COMBINADAS POLIGONAIS E POLIGONAIS DE DUPLA CURVATURA

33 PEÇAS

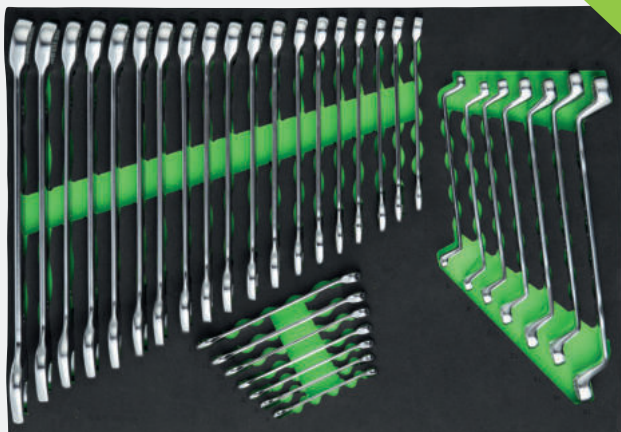

FG 600/B

Chaves poligonales de boca
6, 7, 8, 9, 10, 11, 12, 13, 14, 15, 16, 17, 18, 19, 20, 21, 22, 23, 24, 25, 26, 27, 28, 29, 30, 32



FG 615/B

Chaves de luneta com curvatura profunda
6x7, 8x9, 10x11, 12x13, 14x15, 16x17, 18x19



€/LISTA

~~565,00~~

PROMO

279,00€

FG 100/45R

MÓDULO CHAVES PARA PARAFUSOS DE FENDA, PHILLIPS, HEXAGONAIS ESFÉRICAS Y TORX

25 PEÇAS



FG 22/PH

Chave de fenda para parafusos de perfil Phillips
0x60, 1x150, 2x100, 2x150, 3x150

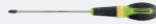

FG 22/PH

Chave de fenda para parafusos de perfil Phillips - Série Stubby
2x30



FG 22/

Chave para parafusos de perfil de fenda
2.5x60, 3x100, 3.5x100, 4x125, 5.5x150, 5.5x100, 6.5x150

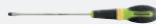

FG 22/TX

Chave de fenda para parafusos de perfil TORX
10, 15, 20, 25, 27, 30



FG 22/H

Chave hexagonais de extremidade esférica
2,5, 3, 4, 5, 6, 8

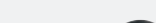

€/LISTA

~~276,40~~

PROMO

149,00€

FG 100/39F

MÓDULO CHAVES PARA PARAFUSOS, ALICATES, Y PONTAS

128
PEÇAS



FG 22/PH
Chave de fenda para parafusos de perfil Phillips
1x150, 2x100

FG 22/
Chave para parafusos de perfil de fenda
3x100, 4x125, 5.5x100

FG 22/TX
Chave de fenda para parafusos de perfil TORX
10, 15, 20, 25, 27, 30

FG 59/XT180
Alicate universales
180mm

FG 63/XT160
Alicate de corte diagonal
160mm

FG 51/180
Alicate de freios exteriores
180mm

FG 53/180
Alicate de freios interiores
180mm

FG 139
Chaves machos hexagonais com extremidade esférica
1.5, 2, 2.5, 3, 4, 4.5, 5, 5.5, 6, 7, 8, 10

FG 85/S100
Jogo 98 pontas 1/4" + 2 porta pontas
PH 0, 1, 2, 3; PZ 0, 1, 2, 3; Tri-Wing 1, 2, 3, 4, 6, 8, 10; XZN 5, 6, 8;
TX 8, 9, 10, 15, 20, 25, 27, 30, 40, 45; S 0, 1, 2, 3;
TX 8, 10, 15, 20, 25, 27, 30, 35, 40; SL 3, 4, 4.5, 5, 5.5, 6, 6.5, 7;
H 1.5, 2, 2.5, 3, 4, 5, 5.5, 6, 1/16, 5/64, 3/32, 7/64, 1/8, 9/64,
5/32, 3/16, 7/32, 1/4;
HTR 2, 2.5, 3, 4, 5, 6, 5/64, 3/32, 7/64, 1/8, 9/64, 5/32; SP 4, 6, 8, 10;
SP 5/32, 3/16, 1/4 + 2 porta pontas 1/4"

FG 88/P14
Porta pontas com pega bi-material
258mm

€/LISTA
~~432,00~~

PROMO
249,00€

FG 100/39E

MÓDULO DE ALICATES Y PONTAS

122
PEÇAS



FG 59/XT180
Alicate universal
180mm

FG 63/XT160
Alicate de corte diagonal
160mm

FG 61/XT160
Alicate de pontas rectas
160mm

FG 69/CJ250
Alicate de pressão, maxilas côncavas
250mm

FG 58/B240
Alicate ajustável com charneira sobreposta
240mm

FG 85/S100
Jogo 98 pontas 1/4" + 2 porta pontas
PH 0, 1, 2, 3; PZ 0, 1, 2, 3; Tri-Wing 1, 2, 3, 4, 6, 8, 10; XZN 5, 6, 8;
TX 8, 9, 10, 15, 20, 25, 27, 30, 40, 45; S 0, 1, 2, 3;
TX 8, 10, 15, 20, 25, 27, 30, 35, 40; SL 3, 4, 4.5, 5, 5.5, 6, 6.5, 7;
H 1.5, 2, 2.5, 3, 4, 5, 5.5, 6, 1/16, 5/64, 3/32, 7/64, 1/8, 9/64,
5/32, 3/16, 7/32, 1/4;
HTR 2, 2.5, 3, 4, 5, 6, 5/64, 3/32, 7/64, 1/8, 9/64, 5/32; SP 4, 6, 8, 10;
SP 5/32, 3/16, 1/4 + 2 porta pontas 1/4"

FG 88/P14
Porta pontas com pega bi-material

FG 139
Chaves machos hexagonais com extremidade esférica
1.5, 2, 2.5, 3, 4, 4.5, 5, 5.5, 6, 7, 8, 10

FG 51/180
Alicate de retenes exteriores
180mm

FG 52/180
Alicate de freios exteriores com pontas curvas 90°
180mm

FG 53/180
Alicate de freios interiores
180mm

FG 54/180
Alicate de freios interiores com pontas curvas 90°
180mm

€/LISTA
~~475,40~~

PROMO
279,00€



CARRINHOS E BANCADAS DE TRABALHO

FG 100/21F

MÓDULO 1/4", 1/2", 3/8" CHAVES DE CAIXA HEXAGONAIS E ACESSÓRIOS

115
PEÇAS



FG 624/E - FG 624E/L
Chaves de caixa de 1/4" - séries normal e longa
4, 5, 6, 7, 8, 9, 10, 11, 12, 13, 14



FG 624/CR14
Roquete reversível, quadra 1/4"-72 dentes



FG 624/PA
Extensões quadras macho fêmea de 1/4" angulares
50, 100mm



FG 624/PR150
Extensões quadras macho fêmea de 1/4"
150mm



FG 624/ES14
Cabo t correção, quadra de 1/4"



FG 624/SN14
Cardam com quadras macho e fêmea de 1/4"



FG 624/GR14C
Quadrado macho de 1/4" com pega



FG 147/H
Chaves de caixa com ponta hexagonais 1/4"
2,5, 3, 4, 5, 6, 7, 8, 10



FG 147/PH
Chaves de caixa com ponta de perfil Phillips - 1/4"
1, 2, 3, 4



FG 147/TX
Chaves de caixa com ponta de perfil Torx 1/4"
9, 10, 15, 20, 25, 27, 30, 40



FG 147/SL
Chaves de caixa com ponta de perfil de fenda 1/4"
4, 5,5, 6,5, 8, 10



FG 139/L
Chaves machos hexagonais com extremidade esférica - série longa
1,5, 2, 2,5, 3, 4, 4,5, 5, 5,5, 6, 7, 8, 10

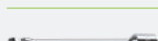

FG 624B/PA
Extensões quadras macho fêmea de 3/8" angulares
75, 125, 150, 250



FG 624/SN38
Cardam com quadras macho e fêmea de 3/8"



FG 624/ES38
Cabo t correção, quadra de 3/8"

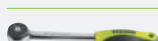

FG 624/CR38
Roquete reversível, quadra 3/8"-72 dentes



FG 624/B
Chave de caixa 3/8" hexagonal
8, 9, 10, 11, 12, 13, 14, 15, 16, 17, 18, 19, 21, 22, 23



FG 625/A
Chave de caixa 1/2" hexagonal
8, 9, 10, 11, 12, 13, 14, 15, 16, 17, 18, 19, 20, 21, 22, 23, 24, 25, 26, 27, 30, 32

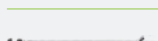

FG 625/PA
Extensões quadras macho fêmea de 1/2" angulares
125, 250

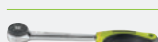

FG 625/CR12
Roquete reversível, quadra 1/2"-72 dentes



FG 625/SN12
Cardam com quadras macho e fêmea de 1/2"



FG 625/ES12
Cabo t correção, quadra de 1/2"

€/LISTA

~~1.030,00~~

PROMO

599,00€

FG 100/81G

MÓDULO CHAVES DE PONTA 1/4" E 1/2"

118
PEÇAS



FG 150/H
Chaves de ponta de perfil macho hexagonal 1/2"
2, 2,5, 3, 4, 5, 6, 8



FG 150L/H
Chaves de ponta de perfil macho hexagonal 1/2" - inserção longa
2, 2,5, 3, 4, 5, 6, 8



FG 150/M
Chaves de ponta XZN 1/2"
5, 6, 8, 10, 12, 14, 16



FG 150L/M
Chaves de ponta XZN 1/2" - inserção longa
5, 6, 8, 10, 12, 14



FG 624/TX
Chave de caixa 1/4" Torx
4, 5, 6, 7, 8, 10



FG 625/TX
Chave de caixa 1/2" Torx
8, 10, 12, 14, 16, 18, 20, 22, 24



FG 147/TX
Chaves de caixa com ponta de perfil Torx 1/4"
9, 10, 15, 20, 25, 27, 30, 40



FG 150/TX
Chaves de ponta de perfil Torx 1/2"
10, 15, 20, 25, 27, 30, 40, 45, 50, 55, 60



FG 138/C
Chaves macho Torx
TX9, TX10, TX15, TX20, TX25, TX27, TX30, TX40, TX45, TX50



FG 150/R
Chaves de ponta de perfil RIBE 1/2"
4, 5, 6, 7, 8, 9, 10, 11, 12, 13, 14



FG 150L/R
Chaves de ponta de perfil RIBE 1/2" série longa
4, 5, 6, 7, 8, 9, 10, 11, 12, 13, 14



FG 147/H
Chaves de caixa com ponta hexagonal 1/4"
2,5, 3, 4, 5, 6, 7, 8, 10



FG 147/PH
Chaves de caixa com ponta de perfil Phillips - 1/4"
1, 2, 3, 4



FG 147/PT
Chaves de caixa com ponta 5 nervuras e furo central - 1/4"
1, 2, 3, 4



FG 147/SL
Chaves de caixa com ponta de perfil de fenda 1/4"
4, 5,5, 6,5, 8, 10



FG 624/CS14
Cabo articulado com punho, quadra 1/4"



FG 625/CS12
Cabo articulado com punho, quadra 1/2"

€/LISTA

~~1.366,00~~

PROMO

499,00€

FG 100/56D
MÓDULO DE FERRAMENTAS DE MANUTENÇÃO GERAL

15
PEÇAS



-  **FG 132/500**
Martelos para mecânico com cabo de resina
500 Gr
-  **FG 136/30**
Martelos com batentes plásticos intercambiável
30 Ø/mm
-  **FG 126/SN**
Escopros planos série nervurada
125mm, 200mm
-  **FG 95/CA**
Paquímetro leitura cinquagesimal
150mm
-  **FG 80/8AR**
Limas meio-murças com punhos - redondo
8"
-  **FG 80/8AM**
Limas meio-murças com punhos - medio redondo
8"
-  **FG 80/8AP**
Limas meio-murças com punhos - plana
8"
-  **FG 80/8AQ**
Limas meio-murças com punhos - triangular
8"
-  **FG 80/8AT**
Limas meio-murças com punhos - quadrado
8"
-  **FG 50/AR**
Serra de recortes compacta com pega
Hoja 140mm
-  **FG 48/LG**
X-acto com lâmina longa
16.7mm
-  **FG 497/OP2**
Oleador pressurizado com palhinha de latão embutida
80cc
-  **FG 44/MT5**
Fitas métricas, fita em aço
5 metri
-  **FG 79/SP4**
Escova com fios de aço ondulados revestidos a latão
270mm

€/LISTA **364,00** **PROMO 229,00€**

FG 100/95B
MÓDULO DE FERRAMENTAS PARA LOJA DE PNEUS

18
PEÇAS







-  **FG 536/2**
Chaves dinâmométricas reversível, para aperto direito-1/2"
40-200Nm
-  **FG 628/R**
Chaves de porcas para rodas
17,19,21mm
-  **FG 198/PE**
Alicate de remoção de pesos de equilíbrio das rodas
-  **FG 186P/S4**
4 Colheres de nylon
-  **FG 628R/L**
Chaves de porcas para rodas - modelo longo
17,19,21mm
-  **FG 126/P500**
Ferros de desmontar rodas de liga leve
-  **FG 628/R**
Chaves de porcas para rodas
16.5x17.5,18.5x19.5,21x21.5,22x22.5,27x27.5

€/LISTA **684,50** **PROMO 399,00€**

FG 100/95C
MÓDULO DE FERRAMENTAS PARA LOJA DE PNEUS

41
PEÇAS



-  **FG 628/R**
Chaves de porcas para rodas
17,19,21mm
-  **FG 628/C**
Chave de caixa 1/2" hexagonal reforçado
10,11,12,13,14,15,16,17,18,19,20,21,22,23,24,25,26,27,30,32mm
-  **FG 628/L**
Chave de caixa 1/2" hexagonais reforçado - série longa
10,13,14,17,19,21,22,24
-  **FG 152/RH**
Chave de ponta reforçada hexagonais de 1/2"
5,6,7,8,10,12,14,17,19
-  **FGA 309**
Chave de impacto
1/2"

€/LISTA **818,50** **PROMO 449,00€**



CARRINHOS E BANCADAS DE TRABALHO



FG 128/2

€/LISTA

~~700,00~~

PROMO
359,00€

BANCADA DE TRABALHO 2.0MT

Prateleira superior em chapa de aço galvanizado de 2 mm

Peso total: 59,5 kg

Capacidade de carga estática: 2000 Kg

Dimensões: 2000x670x880 mm



FG 128/D2

€/LISTA

~~950,00~~

PROMO
489,00€

BANCADA DE TRABALHO 2.0MT EQUIPADO COM 2 GAVETAS

Prateleira superior em chapa de aço galvanizado de 2 mm

Peso total: 74,5 kg

Capacidade de carga estática: 2000 Kg

Dimensões: 2000x670x880 mm



FG 128/D2



FG 128/B2



FG 128/R2



FG 129/2

€/LISTA

~~850,00~~

PROMO
459,00€

BANCADA DE TRABALHO 2.0MT

Prateleira superior em chapa de aço galvanizado de 3 mm

Peso total: 77 kg

Capacidade de carga estática: 2000 Kg

Dimensões: 2000x745x880 mm



FG 129/D2

€/LISTA

~~1.100,00~~

PROMO
599,00€

BANCADA DE TRABALHO 2.0MT EQUIPADO COM 2 GAVETAS

Prateleira superior em chapa de aço galvanizado de 3 mm

Peso total: 92 kg

Capacidade de carga estática: 2000 Kg

Dimensões: 2000x745x880 mm



FG 129/D2



FG 129/B2



FG 129/R2



FG 129/1

€/LISTA
~~550,00~~

PROMO
299,00€

BANCADA DE TRABALHO 1.0MT

Prateleira superior em chapa de aço galvanizado de 3 mm
Prateleira inferior em chapa de aço fornecida de série
2 montantes

Disposições para fixação ao solo
Estrutura pintada com tinta epoxi
Peso total: 58 Kg

Capacidade de carga estática: 2000 Kg
Dimensões: 1000x745x880 mm



FG 129/D1

€/LISTA
~~690,00~~

PROMO
369,00€

BANCADA DE TRABALHO 1.0MT EQUIPADO COM 1 GAVETAS

Prateleira superior em chapa de aço galvanizado de 3 mm
Prateleira inferior em chapa de aço fornecida de série
2 montantes

Disposições para fixação ao solo
Estrutura pintada com tinta epoxi
Peso total: 64.5 Kg

Capacidade de carga estática: 2000 Kg
Dimensões: 1000x745x880 mm



FG 129/D1



FG 129/B1



FG 129/R1



FG 129/1.5

€/LISTA
~~650,00~~

PROMO
349,00€

BANCADA DE TRABALHO 1.5MT

Prateleira superior em chapa de aço galvanizado de 3 mm
Prateleira inferior em chapa de aço fornecida de série
2 montantes

Disposições para fixação ao solo
Estrutura pintada com tinta epoxi
Peso total: 77 Kg

Capacidade de carga estática: 2000 Kg
Dimensões: 1500x745x880 mm

FG 129/D1.5

€/LISTA
~~790,00~~

PROMO
429,00€

BANCADA DE TRABALHO 1.5MT EQUIPADO COM 1 GAVETAS

Prateleira superior em chapa de aço galvanizado de 3 mm
Prateleira inferior em chapa de aço fornecida de série
2 montantes

Disposições para fixação ao solo
Estrutura pintada com tinta epoxi
Peso total: 83.5 Kg

Capacidade de carga estática: 2000 Kg
Dimensões: 1500x745x880 mm



FG 129/D1.5



FG 129/B1.5



FG 129/R1.5



CARRINHOS E BANCADAS DE TRABALHO



FG 137/D1.5

€/LISTA

~~1.400,00~~

PROMO
739,00€

BANCADA ESPECIAL 1.5MT COM TANQUE DE COLETA - CINZENTO ESCURO E RODAS GIRATÓRIAS

Estante microperforado

Depósito recolector extraíble con capacidad de 30 litros

Peso total: 90 Kg

Dimensões: 1500x745x880 mm

Prateleira microperfurada



FG 137/D1.5



FG 137/B1.5



FG 137/R1.5



GAVETA DE COLHEITA DE FLUIDOS



TORNEIRA DE ESGOTOS DE LÍQUIDOS



PRATELEIRA REMOVÍVEL MICROPERFURADA



FG 131/D2

€/LISTA

~~1.700,00~~

PROMO
899,00€

BANCO DE TRABAJO DE 2,0 M CON TABLERO DE ACERO Y CÓMODA DE 5 CAJONES

Peso total: 121.5 Kg

Dimensões: 2000x670x920 mm



FG 131/D2



FG 131/B2



FG 131/R2



FG 132/D2

€/LISTA

~~2.350,00~~

PROMO
1.299,00€

BANCO DE TRABAJO DE 2,0 M CON TABLERO DE ACERO Y DOS CÓMODAS DE 5 CAJONES

Peso total: 163 Kg

Dimensões: 2000x745x920



FG 132/D2



FG 132/B2



FG 132/R2



FG 107/A

€/LISTA

~~165,00~~

PROMO
89,00€

CARRO PORTA FERRAMENTAS

Chapa de aço: 1mm
2 rodízios fixos e 2 rodízios giratórios com travão (Ø100mm)
Profundidade da prateleira: 7,8 cm
Capacidade de carga estática distribuída por 3 prateleiras: 90 kg
Dimensões: 730x380x780
Peso kg: 16,4



FG 106/B

€/LISTA

~~336,00~~

PROMO
199,00€

CARRO PORTA FERRAMENTAS

Dimensões: 460x930x885 mm
Chapa de aço de 1,5 mm
Rodas montadas em suporte de placa rotativa com unidade de rolamento duplo de esferas
2 fixas, 1 giratória + 1 roda giratória com travão (Ø100mm)
Dimensões: 460x930x885
Peso total: 22 Kg



FG 106/C

€/LISTA

~~428,00~~

PROMO
239,00€

CARRO PORTA FERRAMENTAS

Dimensões: 560x1000x950 mm
Chapa de aço 2,0 mm
Rodas montadas em suporte de placa giratória com unidade de rolamento duplo de esferas
2 fixas, 1 giratória + 1 rodízio giratório com travão (Ø125mm)
Dimensões: 560x1000x950
Peso total: 44 Kg



**PRODUÇÃO 100%
MADE IN ITALY**

MOBILIÁRIO FG 118 TÉCNICO



**ACABADO
SATINADO
MATE**



**700mm DE PROFUNDIDADE
BANCADA EM AÇO DE 3mm**

OS DETALHES QUE FAZEM A DIFERENÇA

- TOMADAS ELÉTRICAS STANDARD, SCHUKO E USB
- GAVETAS COM EXTENSÃO TOTAL, EQUIPADAS COM TAPETES DE BORRACHA E OPÇÃO DE INSTALAÇÃO DE DIVISÓRIAS INTERIORES



- ARMÁRIOS COM 4 PRATELEIRAS INTERNAS E DOBRADIÇAS COM AMORTECIMENTO
- TAMPO EM POLICARBONATO
- E NOVO ACABAMENTO RESISTENTE A RISCOS
- ARMÁRIOS ALTOS COM PORTAS EQUIPADAS COM PISTÕES A GÁS



FG 118/CO2V

€/LISTA

~~5.840,00~~

PROMO
2.699,00€

CONFIGURAÇÃO TÉCNICA DO MOBILIÁRIO 2050MM

Configuração composta por:

FG 118V/69A: Módulo de armários com 2 portas

FG 118V/7T: Gaveteiro móvel com 7 gavetas

FG 118V/40F: Módulo porta-papel com gaveta de resíduos

2 porta-ferramentas

2 tomadas fornecidas: 1 x tomada de 2 pinos 220V, 1 x tomada de 2 pinos Schuko + USB

Dimensões: 2050x757x2000 mm



FG 118/CO2D



FG 118/CO2B



FG 118/CO2R



FG 118/CO3V

€/LISTA

~~6.620,00~~

PROMO
3.199,00€

CONFIGURAÇÃO TÉCNICA DO MOBILIÁRIO 2550MM

Configuração composta por:

FG 117V/AR1V: Armário metálico de arrumação com 1 porta

FG 118V/69A: Módulo de armário com 2 portas

FG 118V/7T: Armário móvel de gavetas com 7 gavetas

FG 118V/40F: Módulo porta-papéis com gaveta de resíduos

2 porta-ferramentas

2 tomadas fornecidas: 1 x tomada de 2 pinos 220V, 1 x tomada de 2 pinos Schuko + USB

Dimensões: 2550x757x2000 mm



FG 118/CO3D



FG 118/CO3B



FG 118/CO3R



FG 118/CO30V

€/LISTA

7.670,00

PROMO
3.799,00€

CONFIGURAÇÃO TÉCNICA DO MOBILIÁRIO 3050MM

FG 118V/205A: Estrutura básica para configuração de 2050mm, equipada com 2 unidades de parede superiores

FG 118V/40A: Módulo fixo com portas

FG 118V/7T: Módulo móvel com 7 gavetas

FG 118/69V7: Módulo fixo com 7 gavetas

FG 117/AR1V: Armário alto com portas

FG 117/AR1V: Armário alto com portas

Dimensão mm (LxPxH): 3050x757x2000



FG 118/CO30D



FG 118/CO30B



FG 118/CO30R



EFEITO METÁLICO

ANTIDERRAPANTE

RESISTENTE A MANCHAS

FG 117/PVC-1

€/LISTA
~~22,00~~

PROMO
13,90€

PLACAS DE PVC

- Espessura de 6 mm
- Capacidade de carga: 15-20 t/m²
- Resistente a produtos químicos
- Antiderrapante
- Resistente a manchas
- Sistema de encaixe prático
- Acabamento metálico
- Ideal para oficinas, estabelecimentos comerciais e industriais, etc.

DIMENSÕES:
500x500mm

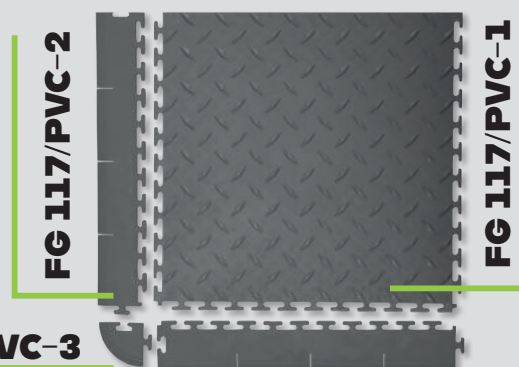

FG 117/PVC-2

€/LISTA
~~8,20~~

PROMO
4,90€

BORDA DE FECHO

DIMENSÕES:
80x500mm



FG 117/PVC-3

€/LISTA
~~5,80~~

PROMO
2,90€

ÂNGULO DE FECHO

DIMENSÕES:
80x80mm



FG 117PVC/S5

€/LISTA
~~227,00~~

PROMO
139,00€



JOGO DE 5 PLACAS EM PVC COM ORLAS E ACABAMENTOS.

- 5PZ FG 117/PVC -1 telha
- 12PZ FG 117/PVC -2 borda
- 4PZ FG 117/PVC -3 angular

FG 117PVC/S6

€/LISTA
~~265,00~~

PROMO
169,00€

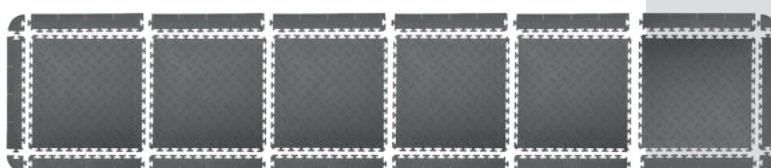

JOGO DE 6 PLACAS EM PVC COM ORLAS E ACABAMENTOS.

- 6PZ FG 117/PVC -1 teja
- 14PZ FG 117/PVC -2 borda
- 4PZ FG 117/PVC -3 angular



FG 118 + SORTIDO

351 PZ

ARMAZENAMENTO
DE FERRAMENTAS EM MÓDULOS
GAVETA COMPLETA

DE VALOR
DESDE 1.980,00€

FG 118V/AS351

€/LISTA
~~11.399,30~~

PROMO
4.999,00€

COM UMA VARIEDADE DE 351 FERRAMENTAS ESSENCIAIS



FG 118B/AS351



FG 118R/AS351



FG 118D/AS351



BANCADA DE AÇO DE 3 MM - PROFUNDIDADE 70 cm

CONFIGURAÇÃO DE MOBILIÁRIO TÉCNICO DE 3050 MM

FG 118V/205A: Estrutura básica equipada com 2 módulos superiores

FG 118V/7T: Cómoda móvel com 7 gavetas

FG 118/69V7: Cómoda fixa com 7 gavetas

FG 118V/40F: Módulo de prancheta com gaveta para o lixo

FG 117/AR1V: Armário de arrumação com 1 porta

FG 117/AR1V: Armário de arrumação com 1 porta

DIMENSÕES:
3050X757X2000mm

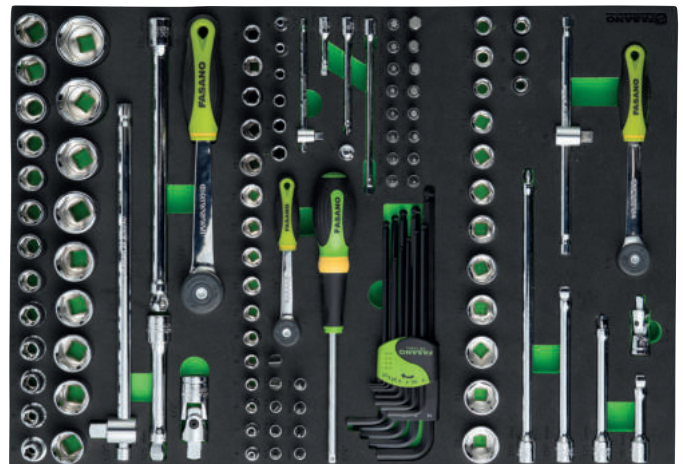
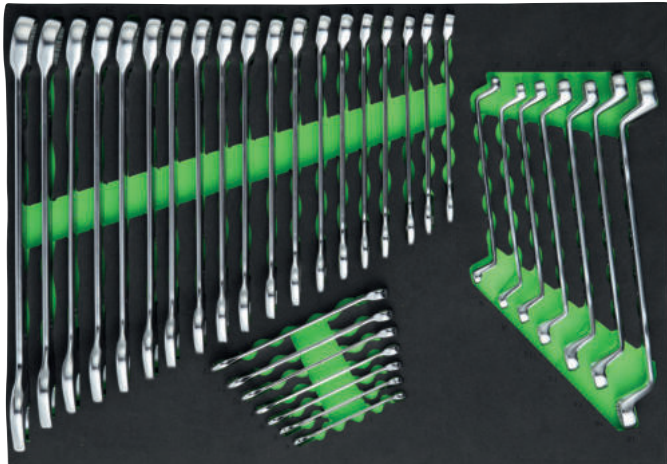

- FG 100/03M:** Módulo de chaves de bocas/fendas com 18 peças
- FG 100/21F:** Módulo de soquetes sextavados, inserções e acessórios de 1/4", 3/8", 1/2"
- FG 100/39E:** Módulo de inserção de 1/4" e alicate
- FG 100/45R:** Módulo de chaves de fendas de fendas, Phillips, sextavada e Torx
- FG 100/56D:** Módulo de ferramentas para manutenção geral
- FG 100/95C:** Módulo de ferramentas para pneus com chave de fendas
- FGA 309**

FGA 309
CHAVE DE IMPACTO DE 1/2"



MARTELO
DUPLA



PAR MAXIMO





SISTEMA DE MOBILIÁRIO TÉCNICO **FG 117**



DISPONÍVEL EM 4 CORES



NEW

BANCADA EM AÇO 2 mm

EQUIPADO COM TAMPA DE POLICARBONATO RESISTENTE A RISCOS AGORA DISPONÍVEL EM DUAS PROFUNDIDADES

ESCOLHA A BANCADA A MELHOR PARA AS SUAS NECESSIDADES

A versão com 600 mm de profundidade

tem o código que termina em **FG 117/... - 60**



PROFUNDIDADE 460mm



PROFUNDIDADE 600mm

PRATELEIRAS INTERNAS E MECANISMO DE FECHO SUAVE

TINTA ACETINADA FOSCO

GAVETAS ADEQUADAS PARA DIVISÓRIAS INTERNAS ARMAZENAMENTO DE PEÇAS PEQUENAS



FG 117/CO2V

€/LISTA
~~4.525,00~~

PROMO
1.899,00€

PROFUNDIDADE 460mm

FG 117/CO2V-60

€/LISTA
~~4.825,00~~

PROMO
2.099,00€

PROFUNDIDADE 600mm

CONFIGURAÇÃO FG 117 DE 2070mm

Configuração composta por:
 FG 117V/68A: Módulo de armário
 FG 117V/7G: Carro de ferramentas
 FG 117V/68B: Armário, suporte para papel e caixote do lixo
 3 estantes para utensílios
 3 gabinetes de pared superiores



FG 117/CO2D - FG 117/CO2D-60



FG 116/CO2B - FG 117/CO2B-60



FG 117/CO2R - FG 117/CO2R-60



FG 117/CO3V

€/LISTA
~~5.395,00~~

PROMO
2.399,00€

PROFUNDIDADE 460mm

FG 117/CO3V-60

€/LISTA
~~5.695,00~~

PROMO
2.599,00€

PROFUNDIDADE 600mm

CONFIGURAÇÃO FG 117 DE 2070mm + ARMÁRIOS

Configuração composta por:
 FG 117V/68A: Módulo de armário
 FG 117V/7G: Carro de ferramentas
 FG 117V/68B: Armário, suporte para papel e utensílios
 FG 117/AR1V: Armário alto - 500x510x2000 mm



FG 117/CO3D - FG 117/CO3D-60



FG 116/CO3B - FG 116/CO3B-60



FG 117/CO3R - FG 117/CO3R-60



FG 117/CO25V

€/LISTA
~~5.675,00~~

PROMO
2.499,00€

PROFUNDIDADE 460mm

FG 117/CO25V-60

€/LISTA
~~5.975,00~~

PROMO
2.699,00€

PROFUNDIDADE 600mm

CONFIGURAÇÃO FG 117 DE 2070mm + ARMÁRIOS

FG 117V/207A: Suporte para ferramentas com prateleiras e 3 módulos superiores

FG 117V/7G: Cómida móvel com 7 gavetas

FG 117V/68A: Módulo de armário com duas portas

FG 117V/68B: Módulo de armário com uma porta

+ Módulo de prancheta com gaveta para o lixo

FG 117/AR2V: Armário com duas portas



FG 117/CO25D - FG 117/CO25D-60



FG 117/CO25B - FG 117/CO25B-60



FG 117/CO25R - FG 117/CO25R-60



FG 117/CO24V

€/LISTA
~~6.000,00~~

PROMO
2.699,00€

PROFUNDIDADE 460mm

FG 117/CO24V-60

€/LISTA
~~6.300,00~~

PROMO
2.899,00€

PROFUNDIDADE 600mm

CONFIGURAÇÃO FG 117 DE 2070mm + ARMÁRIOS

FG 117V/207A: Suporte para ferramentas com prateleiras e 3 módulos superiores

FG 117V/7G: Cómida móvel com 7 gavetas

FG 117V/68V7: Cómida fixa com 7 gavetas

FG 117V/68B: Módulo de armário com 1 porta

+ Módulo de prancheta com gaveta para o lixo

FG 117/AR2V: Armário com duas portas



FG 117/CO24D - FG 117/CO24D-60



FG 116/CO24B - FG 116/CO24B-60



FG 117/CO24R - FG 117/CO24R-60



FG 117/CO16V

€/LISTA
~~3.815,00~~

PROMO
1.799,00€

PROFUNDIDADE 460mm

FG 117/CO16V-60

€/LISTA
~~4.015,00~~

PROMO
1.999,00€

PROFUNDIDADE 600mm

CONFIGURAÇÃO FG 117 DA 1380MM + ARMÁRIO

FG 117V/138A: Estrutura de base com porta-ferramentas e 2 unidades superiores de parede
 FG 117V/68A: Módulo de armário
 FG 117/68V5: Cômada fixa com 5 gavetas
 FG 117/AR1V: Armário alto - 2000x500x510mm
 Dimensão mm (LxPxH): 1875x510x2000



FG 117/CO16D - FG 117/CO16D-60



FG 116/CO16B - FG 116/CO16B-60



FG 117/CO16R - FG 117/CO16R-60

FG 117/CO30V

€/LISTA
~~8.480,00~~

PROMO
3.699,00€

PROFUNDIDADE 460mm

FG 117/CO30V-60

€/LISTA
~~9.080,00~~

PROMO
3.999,00€

PROFUNDIDADE 600mm



CONFIGURAÇÃO ANGULAR FG 117

Configuração composta por:
 FG 117V/68B: Armário, suporte para papel e resíduos
 FG 117V/7G: Carro de ferramentas com 7 gavetas
 FG 117V/68A: Módulo de armário
 FG 117/68V6: Cômada fixa com 6 gavetas
 FG 117V/68A: Módulo de armário



FG 117/CO30D - FG 117/CO30D-60



FG 116/CO30B - FG 116/CO30B-60



FG 117/CO30R - FG 117/CO30R-60



FG 117

O MOBILIÁRIO TÉCNICO
DOS SEUS SONHOS
A UM PREÇO
IMBATÍVEL



FGA 383/AR15
ENROLADOR
AUTOMÁTICO
PARA MANGUEIRA
DE AR COMPRIMIDO
-15mt, Ø8X12mm



FG 117V/AS266

€/LISTA

7.304,00

PROMO
3.499,00€

FG 117V/AS266-60

€/LISTA

7.624,00

PROMO
3.699,00€

PROFUNDIDADE **460mm**

PROFUNDIDADE **600mm**

**COM UM SORTIDO DE 265 FERRAMENTAS
+ CHAVE DE FENDAS GRATIS**



FG 117B/AS266
FG 117B/AS266-60



FG 117R/AS266
FG 117R/AS266-60



FG 117D/AS266
FG 117D/AS266-60

CONFIGURAÇÃO DE MOBILIÁRIO TÉCNICO DE 3070 mm

FG 117V/207A: Unidade com porta-ferramentas e 3 armários de parede

FG 117V/7G: Gaveteiro móvel com 7 gavetas

FG 117V/68A: Módulo de armário com portas duplas

FG 117V/68C: Módulo de ar comprimido + módulo porta-papel e gaveta de resíduos

FG 117/AR2V: Armário de duas portas

TAMANHOS DISPONÍVEIS:

3070x510x2000mm

3070x630x2000mm



SORTIDO

265 PZ

**DE FERRAMENTAS
POR VALOR
DE 900,00 €**

**+ CHAVE DE FENDAS
GRATIS**

**FGA 309
DO VALOR
DE 179,00€**



1º GAVETA

83 PZ

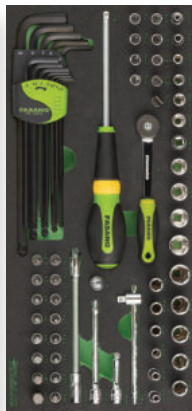

FG 100/03H: Módulo 18 chaves boca/lunetas mm
FG 100/17E: Módulo chaves de caixas 6PT

2º GAVETA

75 PZ

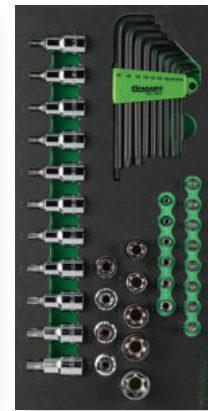

FG 100/45D: Módulo 6 Destornilladores de ponta plana y de estrella
FG 100/21B: Módulo de llave de tubo hexagonal de 1/2"
FG 100/21TX: Módulo de herramientas con accionamiento Torx de 1/4" y 1/2"

3º GAVETA

107 PZ



FG 100/48E: Módulo 18 chaves boca/lunetas mm
FG 100/39XT: Módulo chaves de caixas 6PT
FG 100/42C: Módulo chaves de caixas 6PT

GRATIS

O IMPERDÍVEL

**CHAVE DE IMPACTO
DE 1/2"**



**1.700
Nm**
PAR MAXIMO





FG 117/CO26V

€/LISTA
~~5.960,00~~

PROMO
2.999,00€

PROFUNDIDADE 460mm

FG 117/CO26V-60

€/LISTA
~~6.260,00~~

PROMO
3.299,00€

PROFUNDIDADE 600mm

NEW



**ORDEM
E LIMPEZA
NOS
ESPAÇOS DE
TRABALHO**

**NOVO MÓDULO
COM LAVATÓRIO
INTEGRADO**



BANCADA DE AÇO DE 2mm

**CONFIGURAÇÃO DE MOBILIÁRIO TÉCNICO
2570 MM**

FG 117V/138A: Estrutura com prateleiras para utensílios e 2 armários altos de parede

FG 117V/68LVA: Módulo com suporte para utensílios, armário superior e armário para lava-loiça

FG 117/68V7: Cômada fixa com 7 gavetas

FG 117V/68B: Módulo de roupeiro com 1 porta

+ módulo de prancheta com gaveta de lixo

FG 117/AR1V: Roupeiro com 1 porta

TAMANHOS DISPONÍVEIS

2570X510X2000mm

2570X630X2000mm



**FG 117/CO26B
FG 117/CO26B-60**



**FG 117/CO26R
FG 117/CO26R-60**



**FG 117/CO26D
FG 117/CO26D-60**

FG 117V/68LVB

€/LISTA
~~1.150,00~~

PROMO
689,00€

FG 117V/68LVB-60

€/LISTA
~~1.250,00~~

PROMO
739,00€

PROFUNDIDADE 460mm

PROFUNDIDADE 600mm

NEW



INCLUIDO:
GRIFO MEZCLADOR
GRUPO DE DESAGÜE
TAPA DE CIERRE
TAPA DEL FILTRO

MÓDULO FG 117 COM ARMÁRIO E LAVA-LOIÇA INCORPORADO

Duas portas
Prateleira interna removível
Sistema de fecho central
Cuba em aço inoxidável 400 x 340 x 140 mm

TAMANHOS DISPONÍVEIS

680X460X1015mm
680X600X1015mm



FG 117B/68LVB
FG 117B/68LVB-60



FG 117R/68LVB
FG 117R/68LVB-60



FG 117D/68LVB
FG 117D/68LVB-60

FG 117V/68LVA

€/LISTA
~~1.750,00~~

PROMO
999,00€

FG 117V/68LVA-60

€/LISTA
~~1.850,00~~

PROMO
1.049,00€

PROFUNDIDADE 460mm

PROFUNDIDADE 600mm

NEW



INCLUIDO:
GRIFO MEZCLADOR
GRUPO DE DESAGÜE
TAPA DE CIERRE
TAPA DEL FILTRO

MEDIDAS DISPONIBLES:

690X490X2000mm
690X630X2000mm

MÓDULO FG 117 CON MUEBLES COLGANTES Y MUEBLES COLGANTES Y MUEBLES CON FREGADERO INTEGRADO

- Mueble base con rejilla y mueble superior
- Módulo de mueble con fregadero integrado



FG 117B/68LVA
FG 117B/68LVA-60



FG 117R/68LVA
FG 117R/68LVA-60



FG 117D/68LVA
FG 117D/68LVA-60



MOBILIÁRIO PARA VANS

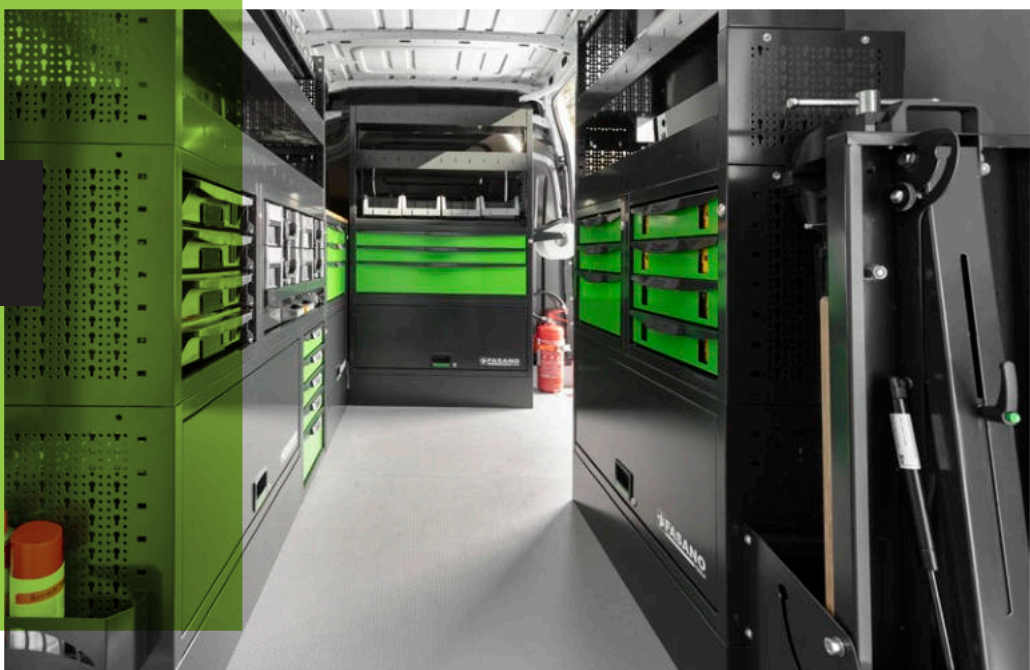

FG 119V/CO16

€/LISTA
2.326,00

PROMO
999,00€

CONFIGURAÇÃO DE MOBILIÁRIO TÉCNICO PARA VANS

Dimensões mm: 980x400x1057

Peso kg: 61,8

Inclui (de cima para baixo)

FG 119/MRT40-9: par de montantes laterais

FG 119/RP40-92: Prateleira com divisórias amovíveis

FG 119V/C49-3: Cómada de 3 gavetas

FG 119V/C49-4: Cómada de 4 gavetas

FG 119V/BA98: móvel inferior aberto

FG 119/RI98: extensão para armários inferiores abertos ou fechados

FG 119/KS: kit de instalação



FG 119V/CO16



FG 119B/CO16



FG 119R/CO16



**CABO EM ABS
COM EMPUNHADURA
ERGONÓMICA**



**GAVETAS COM ABERTURA
TOTAL PARA MÓDULOS DE
FERRAMENTAS**



**MALAS MODULARES
COM COMPARTIMENTOS
PARA PEÇAS PEQUENAS**

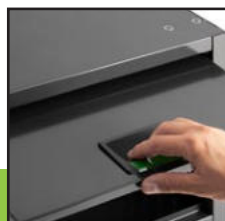

**PORTAS COM ABERTURA
TOTAL**



**BANDEJAS DE PLÁSTICO
PARA PEÇAS PEQUENAS**



PISO ANTIDERRAPANTE



FG 119V/CO12

€/LISTA
~~2.869,00~~

PROMO
1.299,00€

CONFIGURAÇÃO DE MOBILIÁRIO TÉCNICO PARA VANS

Dimensões mm: 980x400x1592

Peso kg: 74,9

Inclui (de cima para baixo)

FG 119/M30-40: par de montantes laterais

FG 119/RV30-92: Prateleira com tabuleiros de plástico

FG 119/RP30-92: prateleira com divisórias amovíveis

FG 119/M40-23: pares de montantes laterais

FG 119/RP40-92: Prateleira com divisórias amovíveis

FG 119V/C49-3: Cômada de 3 gavetas

FG 119V/C49-4: Cômada de 4 gavetas

FG 119V/BA98: móvel inferior aberto

FG 119/R198: extensão para armários inferiores abertos ou fechados

FG 119/KS: kit de instalação



FG 119V/CO12

FG 119B/CO12

FG 119R/CO12

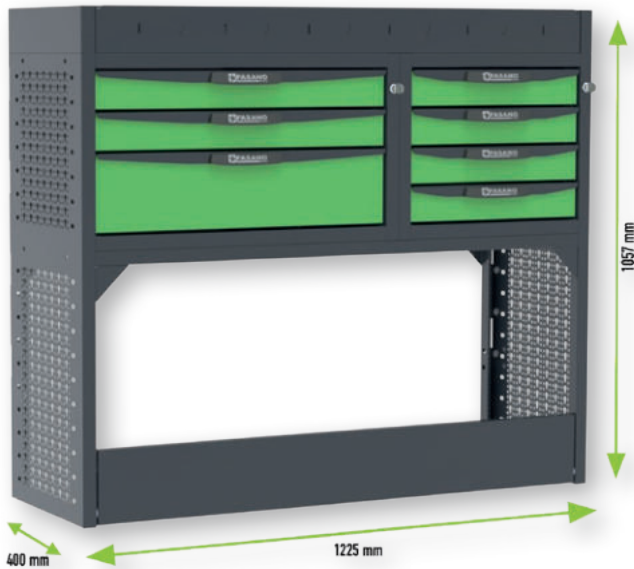

FG 119V/CO25

€/LISTA
~~2.241,00~~

PROMO
1.049,00€

CONFIGURAÇÃO DE MOBILIÁRIO TÉCNICO PARA VANS

Dimensões mm: 1225x400x1057

Peso kg: 76,2

Inclui (de cima para baixo)

FG 119/MRT40-9: par de montantes laterais

FG 119/RP40-116: Prateleira com divisórias amovíveis

FG 119V/C49-4: Cômada de 4 gavetas

FG 119V/C73-3: gaveteiro com 3 gavetas

FG 119/BVF-L122B: base alta com abertura frontal

FG 119/KS: kit de instalação



FG 119V/CO25

FG 119B/CO25

FG 119R/CO25



MOBILIÁRIO PARA VANS



FG 119V/CO33

€/LISTA
~~4.077,00~~

PROMO
1.799,00€

CONFIGURAÇÃO DE MOBILIÁRIO TÉCNICO PARA VANS

Dimensões mm: 1470x400x1360

Peso kg: 114

Inclui (de cima para baixo)

FG 119/M30-40: par de montantes laterais

FG 119/RP30-141: prateleira com divisórias amovíveis

FG 119/RV30-141: Prateleira com tabuleiros de plástico

FG 119V/C49-V1: módulo equipado com 4 caixas de peças pequenas

FG 119V/C98-3: Cómada de 3 gavetas

FG 119V/BA98: base aberta

FG 119V/C49-5B: móvel inferior com 5 gavetas

FG 119/RI98: base elevada para móveis abertos ou fechados

FG 119/KS: kit de instalação



FG 119V/CO33

FG 119B/CO33

FG 119R/CO33



FG 119V/CO18

€/LISTA
~~2.375,00~~

PROMO
1.099,00€

CONFIGURAÇÃO DE MOBILIÁRIO TÉCNICO PARA VANS

Dimensão mm (LxPxH): 980x400x980

Peso kg: 56,5

Inclui (de cima para baixo)

FG 119/98TL: bancada de madeira

FG 119/C49-3: Cómada de 3 gavetas

FG 119/C49-4: Cómada de 4 gavetas

FG 119V/BA98: móvel inferior aberto

FG 119/RI98: elevação para armários inferiores abertos ou fechados

FG 119/KS: kit de instalação



FG 119V/CO18

FG 119B/CO18

FG 119R/CO18



FG 119V/CO27

€/LISTA
~~2.390,00~~

PROMO
1.199,00€

CONFIGURAÇÃO DE MOBILIÁRIO TÉCNICO PARA VANS

Dimensão mm (LxPxH): 1225x400x980

Peso kg: 71,6

Inclui (de cima para baixo)

FG 119/73TL: bancada de madeira

FG 119/49TL: bancada de madeira

FG 119/C49-4: Cômada de 4 gavetas

FG 119/C73-3: Cômada de 3 gavetas

FG 119/BVF-L122B: base alta com abertura frontal

FG 119/KS: kit de instalação



FG 119V/CO27

FG 119B/CO27

FG 119R/CO27



FG 119M/CO13

€/LISTA
~~1.493,00~~

PROMO
799,00€

CONFIGURAÇÃO DE MOBILIÁRIO TÉCNICO PARA VANS

Dimensão mm (LxPxH): 980x400x1592

Peso kg: 38

Inclui (de cima para baixo)

FG 119/M30-40: par de montantes laterais

FG 119/RP30-92: prateleira com divisórias amovíveis

FG 119/RP30-92: Prateleira com divisórias amovíveis

FG 119/M40-23: Pares de montantes laterais

FG 119/M40-40: Pares de montantes laterais

FG 119/RP40-92: Prateleira com divisórias amovíveis

FG 119/RP40-92: Prateleira com divisórias amovíveis

FG 119/BVF-L98B: base com abertura frontal

FG 119/KS: kit de instalação



FG 119M/CO28

€/LISTA
~~1.573,00~~

PROMO
899,00€

CONFIGURAÇÃO DE MOBILIÁRIO TÉCNICO PARA VANS

Dimensão mm (LxPxH): 1225x400x1592

Peso kg: 47

Inclui (de cima para baixo)

FG 119/M30-40: par de montantes laterais

2 x FG 119/RP30-141: prateleiras com divisórias amovíveis

FG 119/M40-23: pares de montantes laterais

FG 119/M40-40: Pares de montantes laterais

2 x FG 119/RP40-141: prateleiras com divisórias amovíveis

FG 119/BVF-L147B: base com painel frontal amovível

FG 119/KS: kit de instalação





AUTOMOTIVE



FG 178/UF

€/LISTA
~~60,00~~

PROMO
37,90€

FUNIL PARA ÓLEO



FG 175/PR

€/LISTA
~~40,00~~

PROMO
24,90€

EXTENSÃO PARA CHAVES DE CAIXA PARA REMOÇÃO DE TAMPA DE ÓLEO

Equipado com um recipiente para recolha de óleo
Ligação de 3/8" - 1/2"
Capacidade de 1200 cc

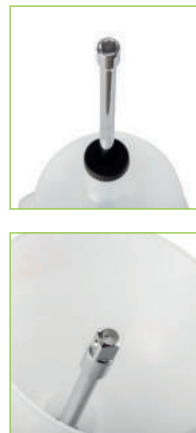

FG 175/S30

€/LISTA
~~221,50~~

PROMO
139,00€

JOGO 28 CHAVES PARA FILTRO DE ÓLEO



FG 175PF/S4

€/LISTA
~~76,50~~

PROMO
48,90€

JOGO DE CHAVES DE 4 FUROS PARA FILTROS DE ÓLEO - MOD. PURFLUX



FG 178/UF83

€/LISTA

~~35,00~~

PROMO
21,90€

CHAVE DE APERTO AUTOMÁTICO PARA REMOVER FILTROS DE ÓLEO

3/8"

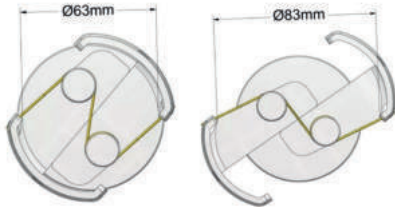

FG 178/FL

€/LISTA

~~46,00~~

PROMO
28,90€

FUNIL FLEXÍVEL DE ALUMÍNIO REVESTIDO A BORRACHA

Flexível e moldável, para facilitar o enchimento e o esvaziamento de líquidos
L/mm 370
L1/mm 170



FG 175/S114

€/LISTA

~~265,00~~

PROMO
169,00€

FERRAMENTAS PARA REPARAÇÃO BUJÕES DE ÓLEO

- M 13x1.25
- M 13x1.5
- M 15x1.5
- M 17x1.5
- M 20x1.5
- M 22x1.5



CHAVE DE FILTRO DE ÓLEO PARA APERTAR COM A MÃO DIREITA E ESQUERDA - MODELO PARA SERVIÇO PESADO

1/2"



CÓDIGO	ØMM	€/LISTA	€/PROMO
FG 178/UF110	80 - 110 mm	120,00	75,00€
FG 178/UF145	104 - 145 mm	176,00	109,00€

FG 175/S15

€/LISTA

~~135,00~~

PROMO
85,00€

JOGO 15 CHAVES MAGNÉTICAS PARA BUJÕES DE ÓLEO

Torx TX45 Soquetes sextavados de 8, 10, 12, 14 e 17 mm
Soquetes sextavados de 13, 14, 17, 18, 19 e 21 mm
Torx TX45



FG 175/S4

€/LISTA

~~72,50~~

PROMO
45,90€

FERRAMENTAS PARA BUJÕES PLÁSTICOS DE ÓLEO

Adequado para VAG TFSI E TDI, FORD, BMW, CITROEN/PEUGEOT



FG 202/PV

€/LISTA

~~230,00~~

PROMO
145,00€

APARELHO DE TESTE DE COMPRESSÃO E DESCOMPRESSÃO





FG 203/S20

€/LISTA
~~379,00~~

PROMO
219,00€

KIT PARA DETECÇÃO DE FUGAS E ENCHIMENTO RÁPIDO DE SISTEMAS DE REFRIGERAÇÃO



TAMPAS OPCIONAIS PARA FG 203/S20



CÓDIGO	MARCA	€/LISTA	€/PROMO
FG 203/BW1	BMW	37,50	22,90€
FG 203/FO1	FORD FIESTA dal 2008	37,50	22,90€
FG 203/FO2	FORD FIESTA	37,50	22,90€
FG 203/FT1	FIAT	44,00	27,90€
FG 203/OP1	OPEL	37,50	22,90€
FG 203/TO1	TOYOTA	37,50	22,90€

FG 201/S7

€/LISTA
~~349,00~~

PROMO
209,00€

KIT PARA PRESSÃO NA SISTEMAS DE CIRCUITO DIESEL

Novo modelo com bomba bidirecional



FG 203/S7

€/LISTA
~~166,00~~

PROMO
104,58€

FERRAMENTA PARA O PREENCHIMENTO DE DEPRESSÃO DOS CIRCUITOS DE REFRIGERAÇÃO

Útil para uma purga perfeita devido à aspiração do circuito de arrefecimento



FG 491/200

€/LISTA
~~40,00~~

PROMO
24,90€

SERINGA PARA FLUIDOS

Fornecido com 2 vedantes de substituição
Capacidade 200cc

FG 491/1500

€/LISTA
~~82,00~~

PROMO
53,90€

SERINGA PARA ÓLEO

Fornecido com 2 vedantes de substituição
Não adequado para combustíveis e óleos minerais
Capacidade 1500cc



FG 491/DF1500

€/LISTA
~~135,00~~

PROMO
79,90€

SERINGA DE EXTRAÇÃO DE COMBUSTÍVEL DO CIRCUITO DIESEL

Equipadas com adaptadores de ligação rápida
Capacidade 1500cc



FG 176/S13

€/LISTA
~~455,00~~

PROMO
269,00€

APARELHO PARA O ENCHIMENTO DE ÓLEO NAS CAIXAS DE VELOCIDADES, TRANSMISSÕES, DIFERENCIAIS

Equipado com 12 acessórios para ligação direta
Equipado com válvula anti-retorno
Capacidade 7.5l



FG 191/S22

€/LISTA
~~629,00~~

PROMO
389,00€

EXTRACTOR UNIVERSAL PARA INJECTORES ELÉCTRICOS DEPLHI, BOSCH SIEMENS E DENSO
Completo com martelo massa 4,8 kg

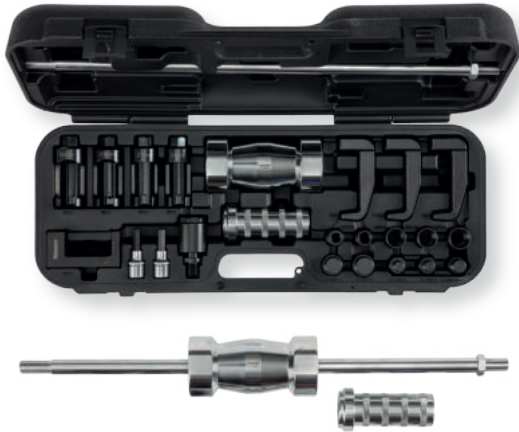

FG 191/S24

€/LISTA
~~479,00~~

PROMO
299,00€

JOGO DE FERRAMENTAS DE EXTRAÇÃO PNEUMÁTICA PARA ELECTRO-INJECTORES BOSCH, DELPHI, SIEMENS E DENSO



FG 190/RI

€/LISTA
~~58,00~~

PROMO
36,90€

EXTRACTOR PARA ANILHAS DE INJECTOR



FG 190/RE

€/LISTA
~~235,00~~

PROMO
149,00€

EXTRATOR DE INJETORES DIESEL M9R - RENAULT / OPEL / NISSAN



FG 190/IP

€/LISTA
~~48,00~~

PROMO
29,90€

FERRAMENTA DE REMOÇÃO BICO DE INJECTORES BOSCH, DELPHI, SIEMENS E DENSO



FG 190/OP

€/LISTA
~~45,00~~

PROMO
27,90€

EXTRATOR DE INJETORES OPEL PARA MOTORES A GASOLINA COM INJEÇÃO DIRETA



FG 190/S8

€/LISTA
~~80,00~~

PROMO
49,90€

KIT EXTRACTOR PARA INJECTORES BMW N54 E MINI N14





FG 191/S14

€/LISTA
~~155,00~~

PROMO
97,90€

KIT DE LIMPEZA DO ASSENTO DO INJETOR

No caso do ABS



CÓDIGO

FG 191/S14-2	1- Varilla roscada M5X0.8XL200mm
FG 191/S14-3	2- Tapón de cierre del asiento del inyector
FG 191/S14-4	3- Cepillo largo para limpiar el asiento del inyector
FG 191/S14-1	4- Extensión flexible
FG 191/S14-6	5- Cepillo de copa Ø 15
FG 191/S14-7	6- Cepillo copa Ø 20
FG 191/S14-8	7- Cepillo Ø 24x85L
FG 191/S14-9	8- Cepillo Ø 18x85L
FG 191/S14-10	9- Cepillo Ø 21x85L

FG 182/S16

€/LISTA
~~570,00~~

PROMO
339,00€

JOGO FERRAMENTAS REMOÇÃO VELAS DE INCANDESCÊNCIA

No caso do ABS



BROCAS DE TITÂNIO



CONE DE CENTRAGEM/
EXTRATOR DE BORDO

FG 183/S5

€/LISTA
~~115,00~~

PROMO
69,90€

JOGO 5 CHAVES PARA VELAS INCANDESCÊNCIA DE MOTOR DIESEL

Conteúdo: 8,9,10,12,14mm



FG 190/S6B

€/LISTA
~~165,00~~

PROMO
99,00€

JOGO PARA LIMPEZA LOCAIS INJETORES

No caso do ABS



FG 181RE/S2

€/LISTA
~~86,00~~

PROMO
53,90€

JOGO 2 CHAVES DE CAIXA POLIGONAIS PARA VELAS

Conteúdo: 14, 16mm



FG 174/SC

€/LISTA
~~118,50~~

PROMO
74,90€

CHAVE REGULÁVEL PARA BÓIAS DO RESERVATÓRIO DE COMBUSTÍVEL

Ømm: 88-170



FG 181/C14

€/LISTA
~~32,50~~

PROMO
19,90€

CHAVES DE CAIXA PARA VELAS PARA MOTORES BMW

Ø 14mm



FG 179/SF

€/LISTA
~~1.900,00~~

PROMO
1.099,00€

EXTRACTOR LÍQUIDO DOS TRAVÕES 12V

Fonte de alimentação de 12 V com cabos de bateria
Compartimento do depósito com tampa e 2 prateleiras traseiras para arrumação
Indicador de nível do líquido dos travões com 3 LEDs
Adequado para líquido dos travões DOT3, DOT4 e DOT5.1
Pressão máxima de 2 bar - Caudal de 2 l/min
4 rodas (duas giratórias, uma com travão)

- Inclui:
- 4 frascos para recuperação de líquido dos travões com tampas e corrente com gancho
 - Mangueira transparente com adaptador de borracha (4 m)
 - 10 tampas diferentes consoante a aplicação
- Tampa cónica
Tampas com mecanismo de baioneta (5, 8, 2)
Tampas com mecanismo de rosca (I2, F2, D2, E2, G2, M2)



NEW



INCLUI 10 CÁPSULAS

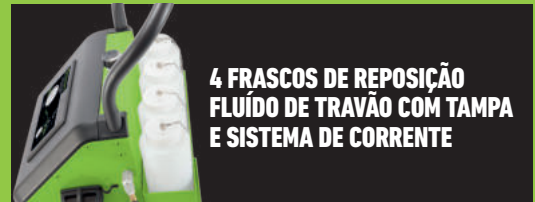
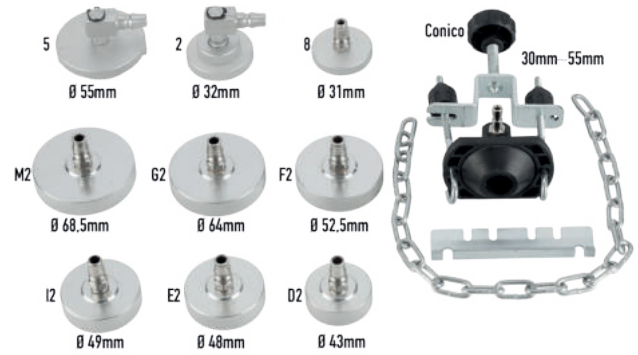

**4 FRASCOS DE REPOSIÇÃO
FLUÍDO DE TRAVÃO COM TAMPA
E SISTEMA DE CORRENTE**



**COMPARTIMENTO DE
ARMAZENAMENTO
COM PORTA
APARENTES**



**INDICADOR DE NÍVEL
DO LÍQUIDO DOS
TRAVÕES
3 LEDS**



**GANCHOS
SUPORTE PARA
BOLHAS DE SABÃO
4 RODAS
(2 GIRATÓRIAS,
1 COM TRAVÃO)**

FG 178/BF

€/LISTA
~~255,00~~

PROMO
159,00€

EXTRACTOR DE LÍQUIDO DE TRAVÕES

Equipado com sondas e ligações universais
Capacidade 2l



FG 178/S6

€/LISTA
~~330,00~~

PROMO
199,00€

JOGO DE FICHAS PARA VEÍCULOS ASIÁTICOS

Toyota, Hyundai, Nissan, Mitsubishi, Mazda, Subaru, Honda, Suzuki





FG 199/PF

€/LISTA
~~239,00~~

PROMO
139,00€

KIT PNEUMÁTICO PARA OS ÊMBOLOS DOS DISCOS DOS TRAVÕES
Para destros e canhotos



FG 172/BS

€/LISTA
~~249,00~~

PROMO
149,00€

FERRAMENTA PNEUMÁTICA PARA INSTALAÇÃO/REMOÇÃO DE CAPAS DE EIXO EM SILICONE

8 maxilas com abertura máxima de 145 mm
Estrutura interna em aço reforçado
Ligação de ar de 1/4"



NEW

FG 186P/S4

€/LISTA
~~24,50~~

PROMO
14,90€

JOGO 4 COLHERES DE NYLON



FG 628/S7

€/LISTA
~~115,00~~

PROMO
69,90€

JOGO 3 CHAVES PARA JANTES DE LIGA LEVE COM ADAPTADORES PARA PARAFUSOS DANIFICADOS

17, 19, 21mm

1/2"



FG 198/PE

€/LISTA
~~65,00~~

PROMO
39,90€

ALICATE DE REMOÇÃO DE PESOS DE EQUILÍBRIO DAS RODAS



CHAVE DE PORCAS PARA RODAS

1/2"



FG 125/LV

€/LISTA
~~20,50~~

PROMO
11,90€

GANCHO DE ALAVANCA UNIVERSAL PARA EIXOS

Para montagem e desmontagem simples e segura de peças de veio.
Graças ao seu design especial pode ser colocado muito próximo da suspensão
L/mm 103 - L1/mm 88 - L2/mm 38 - L3/mm 25

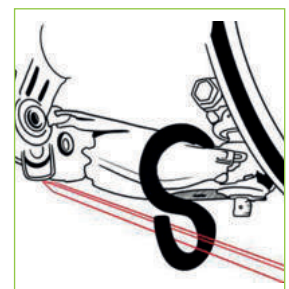

CÓDIGO	MM	APLICACIÓN	€/LISTA	€/PROMO
FG 628/R17.5	16.5x17.5	FIAT, JEEP	€ 21,00	€ 12,90
FG 628/R18.5	18.5x19.5	FORD	€ 21,00	€ 12,90
FG 628/R21.5	21x21.5	FORD GALAXY, VOLVO, TOYOTA	€ 23,00	€ 13,90
FG 628/R22.5	22x22.5	CHRYSLER DODGE, LAND ROVER, RANGE ROVER	€ 23,00	€ 13,90
FG 628/R27.5	27x27.5	LAND ROVER DISCOVERY, RANGE ROVER	€ 26,00	€ 15,90

FG 125/SB

€/LISTA
~~78,00~~

PROMO
49,00€

FERRAMENTA DE SEPARAÇÃO DO BRAÇO OSCILANTE OSCILLANTI

Mecanismo operado por alavanca que utiliza corrediças, roquetes ou chaves que se encaixam num dos três encaixes quadrados de 1/2" da ferramenta. Pinos com revestimento antiderrapante para maior segurança.

NEW

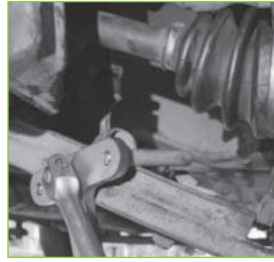

FG 198/DF

€/LISTA
~~380,00~~

PROMO
239,00€

EXTRACTOR DOS CUBOS DAS RODAS E ROLAMENTOS COM 3,4,5 BURACOS

Placa de 10 furos
Para cubos até M12



FG 198/S11

€/LISTA
~~138,00~~

PROMO
82,90€

KIT DE DESMONTAGEM PARAFUSOS PINÇA DE FREIO

Audi, BMW, Ford, Mercedes Benz, Porsche, Volkswagen



FG 168/GA

€/LISTA
~~65,00~~

PROMO
39,90€

FERRAMENTA UNIVERSAL DE ESPALHAMENTO

Elevada capacidade
Utilização universal
Superfícies de pressão paralelas
Capacidade 5 - 11,5 mm



FG 159/PM

€/LISTA
~~230,00~~

PROMO
139,00€

COMPRESSORES DE AMORTECEDORES

Equipado com 2 pares de hastes roscadas
L/mm barra: 65-200/65-370



FG 165/S26

€/LISTA
~~720,00~~

PROMO
459,00€

JOGO DE FERRAMENTAS PARA EXTRACÇÃO E COLOCAÇÃO DE SILENT BLOCK

Bujes para Ø 44-82mm
4 varillas roscadas M10, M12, M14, M16



FG 166/S28

€/LISTA
~~475,00~~

PROMO
299,00€

FERRAMENTAS PARA EXTRACÇÃO E COLOCAÇÃO OLAMENTOS DE RODAS

Desmontagem Ø 34-45mm
Montagem Ø 60-84mm

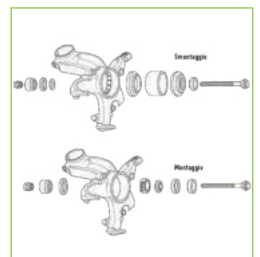

FG 198/S7

€/LISTA
~~82,00~~

PROMO
49,90€

JOGO DE 6 ESCOVAS PARA CUBO DE RODA

COM ADAPTADOR
3 escovas Ø/mm 16

NEW

1/2"





FG 98/B

€/LISTA
~~589,00~~

PROMO
369,00€

IMPULSIONADOR 12V, 22AH

Para arranque de emergência de veículos com baterias de 12V
 Bateria de chumbo-ácido do tipo AGM com capacidade de 22Ah
 Corrente de arranque 800A
 Corrente de arranque 2200A
 Cabos de cobre puro 2AWG, 1,65 metros de comprimento
 Pinças de 1000A com pega em ABS para facilitar a utilização
 Ecrã LCD multifuncional
 Alerta de inversão de polaridade
 LED para indicação da percentagem de carga e da tensão da bateria
 Fusível de proteção de 500A no cabo de pinça vermelho com função de teste de integridade
 Luz LED para iluminar a área de trabalho mesmo à noite
 Tomadas de emergência: isqueiro 12V DC 15A e USB 5V 2,4A (banco de potência)
 Carregador de parede incluído



CABO DE COBRE PURO DE 1,65 M, CALIBRE 2 AWG



FUNÇÃO POWER BANK



CARGADOR INCLUIDO

CE **CORRENTE INICIAL 2200A** **11,9kg**

FG 98/C

€/LISTA
~~1.150,00~~

PROMO
699,00€

IMPULSIONADOR 12/24V, 44AH

Para o arranque de emergência de veículos e veículos comerciais com baterias de 12V ou 24V
 Ideal para automóveis, veículos comerciais, barcos, veículos agrícolas, geradores, etc.
 2 baterias de chumbo-ácido do tipo AGM com capacidade de 22Ah cada
 Corrente de arranque: 1600A a 12V; 800A a 24V
 Corrente de arranque: 4400A a 12V; 2200A a 24V
 Cabos de cobre puro 1AWG, 1,65 metros de comprimento
 Pinças de 1000A com pega em ABS para maior facilidade de utilização
 Ecrã LCD multi-funções
 Alerta de inversão de polaridade
 LED para indicação da percentagem de carga e da tensão da bateria
 Sistema eletrónico de proteção interna da bateria
 Luz LED para iluminar a área de trabalho mesmo à noite
 Tomadas de emergência: isqueiro 12V DC 15A e USB 5V 2,4A (banco de potência)
 Carregador de parede incluído

CORRENTE INICIAL 4400A - 2200A **19,9kg**



LUZES LED VISOR LCD



CABO DE COBRE PURO DE 1,65 M Y 1 AWG



CARGADOR INCLUIDO

CE

FG 97/LT

€/LISTA
~~250,00~~

PROMO
149,00€

ARRANCADOR PORTÁTIL MULTI-FUNÇÕES

Adequado para o arranque de emergência de motores com bateria de 12V
 Ecrã LCD
 2 saídas USB 5V 2.4A
 Cabo 12V 10A para tomada de isqueiro incluído
 Led com 5 modos
 3 modos de carregamento (incluído: carregador, cabo USB tipo C, adaptador 14V 1A para tomada de isqueiro)
 Função Power Bank
 Função Travel Lock
 Fornecido com o boost com pinças de arranque do motor, caixa



CORRENTE INICIAL 800A **CAPACIDADE DE BATERIA 18000mAh**

SISTEMA ELETRÓNICO DE PROTEÇÃO INTERNA DA BATERIA

FG 98/A1.5

€/LISTA

~~66,00~~

PROMO
41,90€

CARREGADOR E MANTENEDOR DE BATERIAS 6/12V - 1.5A

Para baterias de 6 o 12 V (AGM, STD, GEL, LFP)

3 indicadores LED de estado de carga

Protección contra sobrecalentamiento, inversión de polaridad, cortocircuito y sobrecarga

Se suministra con cables con abrazaderas y cables con ojales

Dimensiones: 110 x 63 x 35 mm - Peso: 0,298 kg

NEW



CE



CORRENTE MÁXIMA DE CARREGAMENTO 1.5A

CAPACIDADE DE CARREGAMENTO 10-300Ah

CORRENTE MÁXIMA DE CARREGAMENTO 25A (12V) - 12A (24V)

FG 98/A25

€/LISTA

~~330,00~~

PROMO
179,00€

CARREGADOR E MANTENEDOR DE BATERIAS 12/24V - 25A

Para baterias de 12 ou 24 V (AGM, LIQ, GEL, LFP)

Visor LCD

Painel de controlo

Função Boost para carregamento rápido (35 A a 12 V, 20 A a 24 V)

Função de teste do alternador

Proteção contra sobrecarga e inversão de polaridade

Cabos com garras incluídos

Dimensiones: 250 x 130 x 80 mm - Peso: 1,650 kg

NEW



CE



FG 98/A5

€/LISTA

~~120,00~~

PROMO
75,00€

CARREGADOR E MANTENEDOR DE BATERIAS 6/12V - 5A

Para baterias de 6 o 12 V (AGM, LIQ, GEL, LFP)

Pantalla LCD con panel de control

Protección contra sobrecargas e inversión de polaridad

Cables con abrazaderas y ojales incluidos

Dimensiones: 170 x 85 x 45 mm - Peso: 0,515 kg

NEW



CE

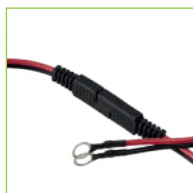

CORRENTE MÁXIMA DE CARREGAMENTO 2.5A (6V) - 5A (12V)

CAPACIDADE DE CARREGAMENTO 5-80Ah

FG 98/A160

€/LISTA

~~1.500,00~~

PROMO
949,00€

CARREGADOR E MANTENEDOR DE BATERIAS 12V - 160A

Para baterias de 12 V (AGM, STD, EFB, GEL, LFP)

Visor LCD

Painel de controlo

Função de teste do alternador

Função de recuperação da bateria descarregada

Proteção contra sobrecarga, inversão de polaridade, sobreaquecimento e curto-circuito

Cabos com garras incluídos

Dimensiones: 270x390x105 mm - Peso: 2 kg

NEW

CE



CORRENTE MÁXIMA DE CARREGAMENTO 10/20/50/80/120/160A

CAPACIDADE DE CARREGAMENTO 14-2000Ah

FG 98/A15

€/LISTA

~~300,00~~

PROMO
189,00€

CARREGADOR DE BATERIAS E MANTENEDOR DE CARGA 6/12/24V

Compatível com baterias de chumbo-ácido e lítio

Visor LCD

8 estágios de carregamento

Função WINTER (ciclo de carregamento otimizado para baixas temperaturas)

Função JUMP (carrega baterias profundamente descarregadas)

Indicador de nível de carga

Identificação de bateria danificada

Função de recuperação de descarga para baterias de chumbo-ácido

Proteção contra sobreaquecimento, inversão de polaridade, curto-circuito e sobrecarga

Cabos com garras de jacaré incluídos

Dimensiones: 200 x 120 x 70 mm - Peso: 1,3 kg



CORRENTE MÁXIMA DE CARREGAMENTO 15A (6V e 12V) - 8A (24V)

CAPACIDAD DE CARREGAMENTO max 150Ah



CE





FG 215/S40

€/LISTA
1.550,00

PROMO
899,00€

TESTER DIGITAL PARA COMPRESSÃO DO MOTOR

Precisão: 1% FS
Software em 8 idiomas (IT, EN, DE, FR, ES, PT, GR, PL)
Pantalla táctil LCD a color retroiluminada de 4,3"
Equipamiento:
Sensor de presión de 0 a 80 bar
Terminales de conexión para batería de 12 V
Kit de racores y mangueras para sistemas de gasolina
Kit de racores y mangueras para sistemas diésel



ACESSÓRIOS BÁSICOS INCLUIDOS



**TESTE DO ALTERNADOR
TESTE DE VOLTAGEM
DA BATERIA**



TESTE DE COMPRESSÃO



**DESENHADO, DESENVOLVIDO
E FABRICADO INTEIRAMENTE EM ITÁLIA**

FG 219/S

€/LISTA
3.350,00

PROMO
1.999,00€

**TESTER DIGITAL PARA COMPRESSÃO DO MOTOR, PRESSÃO DE COMBUSTÍVEL
E PRESSÃO DO ÓLEO DO MOTOR**

Grau de exatidão: 1%FS
Software em 8 línguas (IT, EN, DE, FR, ES, PT, GR, PL)
Ecrã tátil a cores LCD retroiluminado, 4,3"
2 sensores de pressão (0-80 Bar e 0,2500 Bar)



**TESTE DO ALTERNADOR
TESTE DE VOLTAGEM DA
BATERIA**



TESTE DE COMPRESSÃO



**TESTE DE PRESSÃO
DE COMBUSTÍVEL
(ALTA E BAIXA)**



**TESTE DE ÓLEO
DO MOTOR**

**POSSIBILIDADE DE GUARDAR E DESCARREGAR
TESTES PARA UM COMPUTADOR,
PERSONALIZANDO A FOLHA DE DADOS COM
TODAS AS INFORMAÇÕES DO CLIENTE**



FG 220/BT

€/LISTA
~~429,00~~

PROMO
249,00€

TESTER DIGITAL PARA BATERIAS 12V E 24V

Tensão de funcionamento: 9V a 35V DC

Tempo de verificação da bateria: aprox. 1 minuto

Pilha interna para a memória data/hora: CR1220 (1 unidade)

Medidas mm 90x50x235



CARACTERÍSTICAS:	DISPLAY ILUMINADO
	SOFTWARE 6 LINGUAS: italiano; ingles; espanhol; polaco; alemão; francês
	IMPRESSORA INTEGRADA COM ROLO DE PAPEL TÉRMICO
	SISTEMA DE DETECÇÃO FALSA CONTACTO COM PINÇA
APLICAÇÃO:	TESTE DE BATERIA 12 E 24V
	TEST E DE ALTERADOR (INTELIGENTE E NORMAL) 12-24V CARGA
	TESTE DE SISTEMA DE ARRANQUE
SUPORTA BATERIAS DE:	PB, WET, GEL AGM, AGM FLAT, EFB
NORMAS:	CCA: 100-1700; IEC: 100-1000; EN: 100-1700; DIN: 100-1000; JIS
COMPRIMENTO DO CABO:	570 mm

FG 220/EN

€/LISTA
~~489,00~~

PROMO
299,00€

VIDEOSCÓPIO DIGITAL COM Sonda FLEXÍVEL E ORIENTÁVEL

Sonda com 1 metro de comprimento e orientável a 360° para máxima flexibilidade

Diâmetro da sonda de 5,5 mm para aceder até aos pontos mais estreitos e difíceis de alcançar

Ecrã LCD de 4,3" para imagens nítidas e detalhadas com elevada precisão

Sonda concebida para resistir às condições mais difíceis (temperatura de utilização de -10 °C a 50 °C)

Ângulo de visão de 90°

Profundidade de campo visual de 15 a 100 mm

Resolução máxima Full HD 1920x1080 pixels

Bateria de lítio integrada de 3,7 V - 2600 mAh

Autonomia da bateria de até 4 horas

Tempo de recarga de 4 horas

Fornecido em estojo de nylon semirrígido

Vem com um cartão SD de 32 GB, cabo USB-C e dois panos para limpeza de lentes e ecrã

Dimensiones mm 220x123x48

Peso 364 gr

NEW



VEM NUMA CAIXA DE NYLON SEMIRRÍGIDA.

ECRÃ LCD DE 4,3 POLEGADAS

ENDOSCÓPIO DIGITAL

INSPEÇÃO E MANUTENÇÃO DE MÁQUINAS E SISTEMAS



MAIS INFORMAÇÕES

SONDA COM 6 LUZES LED AJUSTÁVEIS EM 3 MODOS

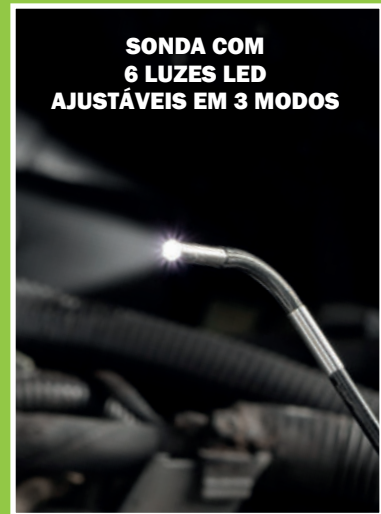

INCLUI CARTÃO SD DE 32 GB PARA GRAVAÇÃO E ARQUIVAMENTO DE IMAGENS, VÍDEOS E ÁUDIO

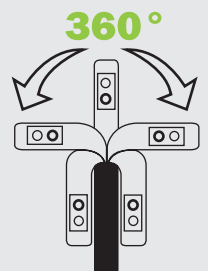

SONDA DE 1 METRO AJUSTÁVEL A 360° PARA MÁXIMA FLEXIBILIDADE

Ø Sonda 5,5mm



FG 179/ST

€/LISTA
~~25,00~~

PROMO
15,90€

CHAVE DE CAIXA PARA INSTALAÇÃO/REMOÇÃO DO SISTEMA START-STOP DO GRUPO PSA

Encaixe quadrado de 1/2"

Perfil frontal triangular especial

Adequado para veículos micro-híbridos Peugeot, Citroen e Hdi

NEW



FG 172/AS2

€/LISTA
~~120,00~~

PROMO
75,00€

ALICATE COM EXTENSÃO PARA ABRAÇADEIRAS COM EXTENSÃO INTERCAMBIÁVEL

Abertura mm 3-52



FG 172/FA

€/LISTA
~~72,50~~

PROMO
39,90€

ALICATE UNIVERSAL PARA ABRAÇADEIRAS



FG 172/TC

€/LISTA
~~35,00~~

PROMO
19,90€

ALICATES PARA REMOVER PINOS DE CORRENTE



FG 172/PA

€/LISTA
~~72,00~~

PROMO
45,90€

ALICATE PARA ABRAÇADEIRAS EM AÇO INOX

Também adequado para braçadeiras de cabos Panduit

Ømm 4.7 - 9.5



FG 172/TG

€/LISTA
~~49,50~~

PROMO
29,90€

ALICATE PARA TUBOS DE ÁGUA E COMBUSTÍVEL



FG 172/MA

€/LISTA
~~98,00~~

PROMO
59,90€

ALICATE DE PRESSÃO

Com mordentes ajustáveis multi-grip



FG 181/PM2

€/LISTA
~~93,00~~

PROMO
49,00€

EXTRACTOR UNIVERSAL DE POLIAS



FG 171/FL

€/LISTA

~~52,00~~

PROMO
32,90€

ALICATE GIRATÓRIO DE ENGATE RÁPIDO PARA TUBOS DE COMBUSTÍVEL,
COM MANDÍBULAS ARTICULADAS



FG 171/N

€/LISTA

~~34,00~~

PROMO
21,50€

ALICATE DE LIGAÇÕES RÁPIDAS COMBUSTÍVEL



FG 184/S5

€/LISTA

~~175,00~~

PROMO
109,00€

JOGO DE 5 CHAVES DE PORCA DO TENSOR DA CORREIA
13,15,16,17,19mm



FG 172/RL2

€/LISTA

~~25,00~~

PROMO
15,90€

ALICATE PARA REMOÇÃO DE RELAYS
Ømm 15-50



FG 172/GO2

€/LISTA

~~110,00~~

PROMO
69,90€

ALICATE PARA ABRAÇADEIRA OETIKER

3/8"



FG 172/OT

€/LISTA

~~58,00~~

PROMO
33,90€

ALICATE PARA ABRAÇADEIRA OETIKER



FG 184/S4

€/LISTA

~~98,00~~

PROMO
61,90€

JOGO DE CHAVES TENSORAS PARA TENSOR DE CORREIA

Para o Grupo VAG (1.8L - 2L a gasolina, 1.9L - 2L a gasóleo), PSA (1.4L-1.5L-1.6L-2L-2.2L a gasóleo), FCA (0.9L TwinAir a gasolina)

NEW



3/8"



FG 172/CA

€/LISTA

~~60,00~~

PROMO
34,90€

ALICATE PARA CACHIMBO DE VELA

Ømm: 14
L/mm: 290





SETOR DA CARROCERÍA

AS MELHORES HERRAMIENTAS, PARA VERDADEROS PROFESIONALES

FG 130AL/S5

€/LISTA

~~37,50~~**PROMO**
23,90€

JOGO DE PUNÇÕES DE PLÁSTICO E PUNÇÃO DE ALUMÍNIO
1 broca de alumínio ajustável 70mm-100mm
Rosca M8x1,25
4 punções de borracha dura, resistente a impactos e a riscos



FG 130/S10

€/LISTA

~~650,00~~**PROMO**
409,00€

JOGO 10 FERRAMENTAS PARA CARROÇARIAS

Conteúdo: Espátulas em formato de colher e de colher de pedreiro, espátulas para trilho, vírgula, calcanhar e curvas, martelos com cabeças redondas e quadradas/pontiagudas, malho e porta-lima com lima.



FG 184P/S3

€/LISTA

~~27,00~~**PROMO**
15,90€

JOGO DE 3 RASPADORES DE PLÁSTICO
Material: polipropileno de alta resistência



FG 185P/S4

€/LISTA

~~29,50~~**PROMO**
17,90€

KIT DE 4 ALAVANCAS PARA PEÇAS PLÁSTICAS

Material: Nylon e fibra de vidro
Elevada resistência à torção
Equipado com orifício para pendurar



FG 188/P1

€/LISTA

~~21,00~~**PROMO**
11,90€

ALAVANCA PARA PEÇAS PLÁSTICAS
Material: Nylon e fibra de vidro
Elevada resistência à torção
Equipado com orifício para pendurar



FG 188P/S2

€/LISTA

~~43,00~~**PROMO**
24,90€

KIT DE CUNHA PARA REMOÇÃO DE MOLDURAS DE PLÁSTICO

Material: polipropileno de alta resistência
1 unidade com pega resistente à percussão
1 unidade sem pega, ideal para espaços reduzidos



FG 184R/S3

€/LISTA

~~48,00~~

PROMO
28,90€

JOGO DE 3 RASPADORES DE AÇO COM CABO DE ABS

L1/mm 280
L2/mm: 10,8 - 25 - 40

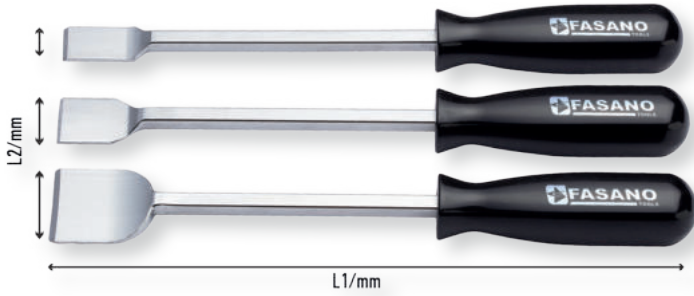

FG 186P/S5

€/LISTA

~~37,50~~

PROMO
19,90€

JOGO 5 EXTRACTORES DE CAVILHAS DE NYLON



FG 184/R1

€/LISTA

~~22,00~~

PROMO
12,90€

RASPADOR DE AÇO COM CABO DE ABS

L1/mm 280
L2/mm: 19

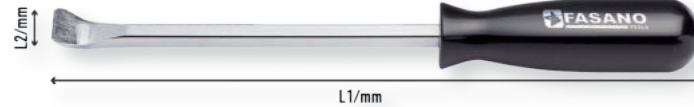

FG 186/S5

€/LISTA

~~98,00~~

PROMO
59,90€

JOGO DE 5 EXTRACTOR DE CAVILHAS, LÂMINA DE AÇO INOXIDÁVEL



FG 184/R2

€/LISTA

~~24,00~~

PROMO
13,90€

RASPADOR DE AÇO COM PROTEÇÃO EM PVC E CABO EM ABS

L1/mm 275
L2/mm: 25,6

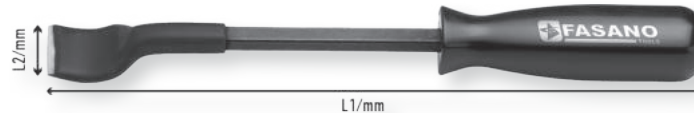

FG 186/AL1

€/LISTA

~~26,00~~

PROMO
15,90€

ALAVANCA METÁLICA EXTRA PLANA

Design único da lâmina com um lado curvo e outro reto para remover fixadores internos e externos mesmo nos espaços mais apertados
Ponta fina e de alta resistência



FG 185B/S2

€/LISTA

~~42,50~~

PROMO
24,90€

JOGO DE 2 EXTRACTORES DE CAVILHAS COM CABO DE ABS



FG 186/S4

€/LISTA

~~27,50~~

PROMO
16,90€

CONJUNTO DE 4 GANCHOS COM LÂMINA DE AÇO

Com pega bimaterial



FG 185/S5

€/LISTA

~~98,00~~

PROMO
59,90€

JOGO DE 5 EXTRACTORES DE CAVILHAS COM CABO DE ABS

Conteúdo: FG 185/A1, FG 185/A2, FG 185/A6,
FG 185/A7, FG 185/A8



**FG 185/CR**

€/LISTA

~~11,50~~**PROMO
6,90€****FERRAMENTA DE REMOÇÃO DE MOLA**

Ideal para retirar as molas C das manivelas das janelas

**FG 185/RM**

€/LISTA

~~32,50~~**PROMO
19,90€****FERRAMENTA DE REMOÇÃO DE PEGA DE APOIO DE MÃO - GRUPO VAG**Pega em ABS
L/mm 255**FG 185/OM**

€/LISTA

~~31,50~~**PROMO
19,90€****FERRAMENTA DE REMOÇÃO DO CLIP OMEGA**

Para Grupo VAG, Tesla, Mercedes-Benz (2008 ~ 2020)

Utilizável também para remover cliques semelhantes ao revestimento da bagagem Tesla (Modelo Y) e ao revestimento da porta Tesla (Modelo Y)

**KIT DE 3 ALAVANCAS DE PLÁSTICO**

CÓDIGO		€/LISTA	€/PROMO
FG 186/S3	3 LEVERINI	12,00	6,90€
FG 186/S3B	3 MANOS	12,00	6,90€

FG 189/PO1

€/LISTA

~~23,00~~**PROMO
12,90€****FERRAMENTA DE REMOÇÃO DO CILINDRO DE TRAVAMENTO DA PORTA - GRUPO VAG****FG 183/RV1**

€/LISTA

~~22,00~~**PROMO
12,90€****FERRAMENTA DE REMOÇÃO DE VEDAÇÃO DE VIDRO**Pega em ABS
L/mm 255**FERRAMENTA DE REMOÇÃO DE FARPAS**Ideal para a limpeza do canal da janela
Ponta esférica para evitar danificar as calhas das portas**FG 189/PO2**

€/LISTA

~~41,00~~**PROMO
23,90€****FERRAMENTA DE REMOÇÃO DO CILINDRO DE FECHO DAS PORTAS - GRUPO VAG**

CÓDIGO	L/MM	€/LISTA	€/PROMO
FG 182/RG10	255	21,00	11,90€
FG 182/RG24	320	27,50	15,90€

FG 183/CM

€/LISTA

~~51,50~~

PROMO
29,90€

FACA MANUAL EQUIPADA COM CABO E SISTEMA DE PARADA DE CABO

Cabo e pega revestidos a PVC

Fornecida com lâmina de 25 mm já montada



FACA DE CORTE

Fornecido com cabo revestido a PVC de uma lâmina

Sistema de bloqueio da lâmina com parafuso



CÓDIGO	L/MM	€/LISTA	€/PROMO
FG 183/CK250	250	22,00	13,90€
FG 183/CK450	450	35,00	21,90€
FG 183/CK600	600	44,00	26,90€

FG 187/GU

€/LISTA

~~29,50~~

PROMO
17,90€

ALAVANCA PARA VIDROS

L1/mm: 345 - L2/mm: 145



FG 187/S7

€/LISTA

~~229,00~~

PROMO
139,00€

FERRAMENTAS PARA VIDROS DE VIATURAS



FG 183/RA1

€/LISTA

~~27,00~~

PROMO
15,90€

RASPADOR MANUAL DE LÂMINA RETA

Fornecido com um cabo ABS de uma lâmina com orifício para pendurar

Equipado com proteção da lâmina em ABS



FG 187/GR

€/LISTA

~~31,00~~

PROMO
17,90€

**FERRAMENTA UNIVERSAL PARA
FIXAÇÃO DE JUNTAS**

Equipado com 6 acessórios

Sistema de guia de rolos

Pega em ABS



FG 187/GU2

€/LISTA

~~29,50~~

PROMO
16,90€

GUIA DE OS COM CABO EM T EM ABS

L/mm: 320



FG 187/K40

€/LISTA

~~196,00~~

PROMO
119,00€

VENTOSA SIMPLE COM ALÇA E SISTEMA DE BOMBEAMENTO

Capacidade 40Kg

Diâmetro: 178mm - 7"





FG 187/S2

€/LISTA
~~800,00~~

PROMO
479,00

CONJUNTO DE REMOÇÃO DO PARA-BRISAS COM SISTEMA DE VENTOSA DE ROQUETE

Caixa em ABS
Ventos de 150 mm com bomba manual
Enrolador de fio de corte com encaixe de 10 mm (3/8")
Capacidade máxima de aspiração: 50 kg por ventosa



1. Passe os fios de cristal curtos (recomendado FG 187/NY) pelo lado de dentro da casa pelo exterior da casa, perfurando o vedante do pára-bris com um guia de arame.



MAIS INFORMAÇÕES

2. Passe o cabo por fora do perímetro do pára-bris, no espaço entre a carroçaria e o vidro, fixando-o a um ponto de ancoragem.

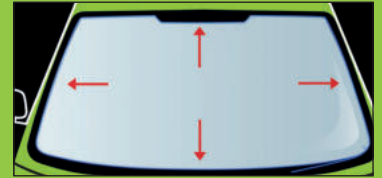

3. Continue a instalar as duas ventosas no pára-bris com a bomba manual. Certifique-se de que seleciona a linha vermelha para obter a máxima sucção.

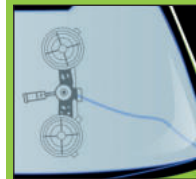

4. Insira a outra extremidade do cabo no poste e ajuste-o com uma braçadeira. Para obter a tensão máxima, utilize a terceira ventosa para manter um ângulo de 45° enquanto puxa o cabo.

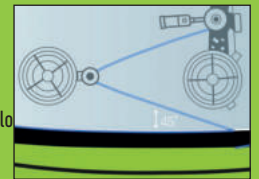

FG 188P/S4

€/LISTA
~~72,00~~

PROMO
44,90€

CONJUNTO DE PROTEÇÃO DO PAINEL DE INSTRUMENTOS COM PEGA



FG 165BC/S6

€/LISTA
~~230,00~~

PROMO
139,00€

CONJUNTO DE 6 EXTRACTORES PARA BRAÇOS DO LIMPA PARA-BRISAS

1: VW, Porsche; 2: Ford, Seat, Mercedes; 3: BMW, VW; 4: Audi A3-A4-A5-A6; 5: VW, Opel, Honda; 6: Audi Q7



FG 187/PN

€/LISTA
~~265,00~~

PROMO
169,00€

JOGO DE REPARAÇÃO MOSSAS, COM 3 VENTOSAS

Ventose: Ø/mm 130, 100, 80



FG 166/DS19

€/LISTA
~~75,00~~

PROMO
46,90€

FG 166/DS24

€/LISTA
~~75,00~~

PROMO
46,90€

DISPENSADOR DE FITA ADESIVA

Permite a aplicação fácil, rápida e precisa da fita. Pode ser montado na parede utilizando o kit de montagem fornecido.



NEW

FG 104V/AS284

€/LISTA
~~4.281,00~~

PROMO
1.699,00€

CARRO DE FERRAMENTAS FG 104 DE 7 GAVETAS COM 284 FERRAMENTAS EM MÓDULOS DE BORRACHA PARA CARROCERIA



CÓDIGO

FG 104V/AS284	FG 104B/AS284	FG 104R/AS284	FG 104D/AS284
---------------	---------------	---------------	---------------

SORTIDO 284 FERRAMENTAS

1º GAVETA

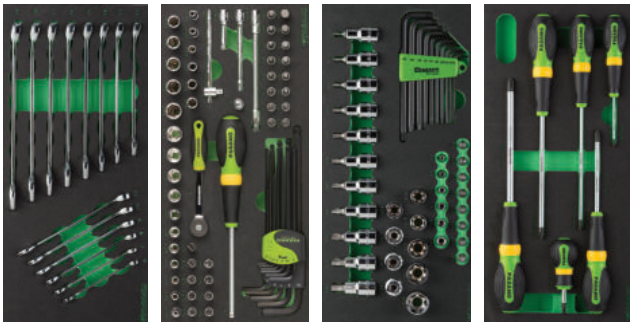

- FG 100/036: Módulo rígido 14 llaves boca/ lunetas poligonales
- FG 100/17E: Módulo 65 herramientas de 1/4"
- FG 100/21TX: Módulo rígido 44 herramientas torx
- FG 100/45F: Módulo 6 llaves de fenda Phillips

2º GAVETA



- FG 100/45I: Módulo 6 llaves de fenda Torx
- FG 100/45T: Módulo 5 llaves de fenda sextavadas
- FG 100/56C: Módulo de percussão
- FG 100/81F: Módulo de inserção sextavado e XZN 1/2"

3º GAVETA

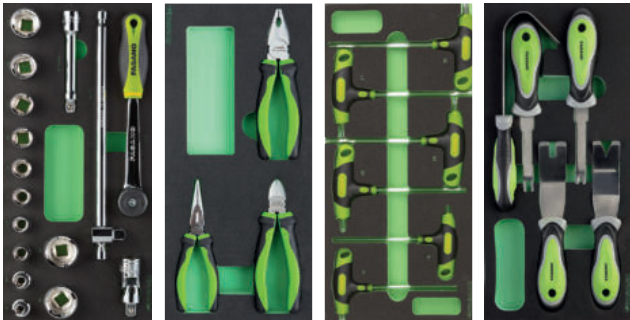

- FG 100/21M: Módulo 16 llaves de caixas 6PT
- FG 100/39XT: Módulo 3 alicates
- FG 100/50G: Módulo de llaves machos Torx
- FG 100/68: Módulo 5 extractores de cavilhas

4º GAVETA



- FG 100/52A: Módulo 8 extractores de cavilhas
- FG 100/52B: Módulo 26 ferramenta de corte para carroçaria
- FG 100/VA4: Módulo porta objetos
- FG 100/52C: Módulo 5 ferramenta para janelas e vidros

5º GAVETA



- FG 100/52D: Módulo 10 raspadores em nylon
- FG 100/52E: Módulo 5 cunhas em plástico
- FG 100/52F: Módulo 5 raspadores em aço
- FG 100/52G: Módulo 5 ferramentas de desmontar

6º GAVETA



- FG 100/52H: Módulo ferramentas para carrçaria
- FG 100/VA1: Módulo porta objetos

SURTIDO COMPLETO PARA CARROCERIA





FERRAMENTAS ESSENCIAIS PARA ENFRENTAR OS NOVOS DESAFIOS DO FUTURO

THE HYBRID REVOLUTION

26 KIT DE FERRAMENTAS ISOLADAS. COMPLETO COM CAPACETE DIELÉTRICO E LUVAS DIELÉCTICAS 1000 V

IDEAL PARA TRABALHOS EM VEÍCULOS ELÉTRICOS E HÍBRIDOS



CÓDIGO	TAMANHO DA LUVA	€/LISTA	€/PROMO
FG 603/S28A	Talla 9	1.048,50€	559,00€
FG 603/S28B	Talla 10	1.048,50€	559,00€

FG 100V/AS56

€/LISTA
~~2.743,00~~

PROMO
1.499,00€

FG 100 CARRO DE FERRAMENTAS DE 6 GAVETAS COM UM SORTIDO DE 56 FERRAMENTAS ISOLADAS EM MÓDULOS DE BORRACHA COM UM SORTIDO DE 56 FERRAMENTAS ISOLADAS



CÓDIGO

FG 100V/AS56	FG 100B/AS56	FG 100R/AS56	FG 100D/AS56	FG 100W/AS56
--------------	--------------	--------------	--------------	--------------

**Sortido de 56 ferramentas isoladas
Em conformidade com a norma IEC 60900 1000V**

1º GAVETA

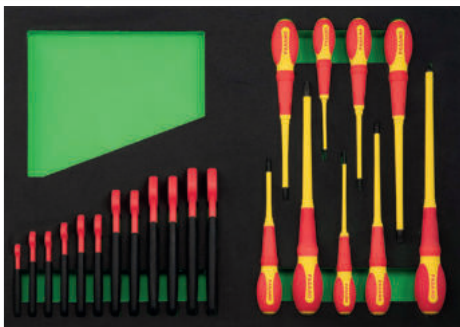

FG 100/03-IS: Módulo chaves de boca simples e chaves para parafusos isoladas
 - Chaves de boca simples isoladas 7-19mm
 - Chaves para parafusos de fenda 2.5x75mm, 3x100mm, 5.5x125mm, 6.5x150mm, 8x175mm
 - Chaves para parafusos Phillips PH0x60, PH1x80, PH2x100, PH3x150

2º GAVETA



FG 100/21-IS: Módulo chaves de caixa 1/2" y accesorios aislados
 - Chaves de caixa 1/2" 10-32mm
 - Chaves de ponta 1/2" baixos y longos 4-10mm
 - Accesorios de 1/2"

3º GAVETA



FG 100/39-IS: Módulo alicates e ferramentas de corte
 - Alicates isoladas
 - Tesoura isoladas
 - Navalha de descarnar cabo
 - Ferramenta para descarnar cabo



FG 603/TA1

€/LISTA
~~286,00~~

PROMO
179,00€

TAPETE ISOLANTE 1.000V
 Dimensiones 1.000 x 1.000 x 3 mm
 Clase de aislamiento 3
 Tensión de funcionamiento: 26500 V
 Cumple con la norma IEC-EN 61111





COMPRESSOR PNEUMÁTICO

DESIGN APRIMORADO PARA AUMENTAR O CONFORTO E A SEGURANÇA DO OPERADOR DURANTE O USO

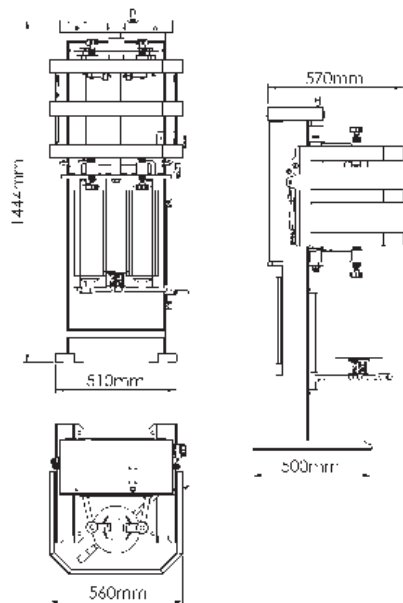

NEW

**+11 CM
MAIS ACIMA
PARA TRABALHAR
COM MAIS
CONFORTO**



Novo mecanismo de elevação da jaula com pistão a gás, para facilitar as manobras e evitar o abaixamento acidental



Cabo de segurança que mantém o pistão no lugar mesmo que o amortecedor seja inserido incorretamente



Maior altura da gaiola para uma maior área de superfície protetora



GARRAS EM AÇO TEMPERADO C45, com tratamento térmico adequado, para elevada resistência mecânica

FG 750/1P

€/LISTA
~~3.000,00~~

PROMO
1.599,00€

COMPRESSOR PNEUMÁTICO PARA MOLAS DE AMORTECEDORES

Potência de impulso: 1,2 toneladas (10 bar) - 0,9 toneladas (8 bar)
Curso de compressão da mola: 300 mm



FG 750/2P

€/LISTA
~~3.700,00~~

PROMO
1.899,00€

COMPRESSOR PNEUMÁTICO PARA MOLAS DE AMORTECEDORES COM 2 PISTÕES

Potência de impulso: 2,4 toneladas (10 bar) - 1,9 toneladas (8 bar)
Curso de compressão da mola: 300 mm



FG 752/1P

€/LISTA
~~3.700,00~~

PROMO
1.799,00€

COMPRESSOR PNEUMÁTICO DE MOLAS COM VISOR DIGITAL

O visor digital mostra a pressão aplicada durante a utilização.



VISOR DIGITAL

FG 752/2P

€/LISTA
~~4.400,00~~

PROMO
2.099,00€

COMPRESSOR PNEUMÁTICO DE MOLAS COM VISOR DIGITAL COM 2 PISTÕES

O visor digital mostra a pressão aplicada durante a utilização.



VISOR DIGITAL



PRENSAS HIDRÁULICAS

NEW



20 t

30 t

50 t

MODO DE FUNCIONAMIENTO DUPLO:
MANUAL COM PALANCA E NEUMÁTICO COM PEDAL

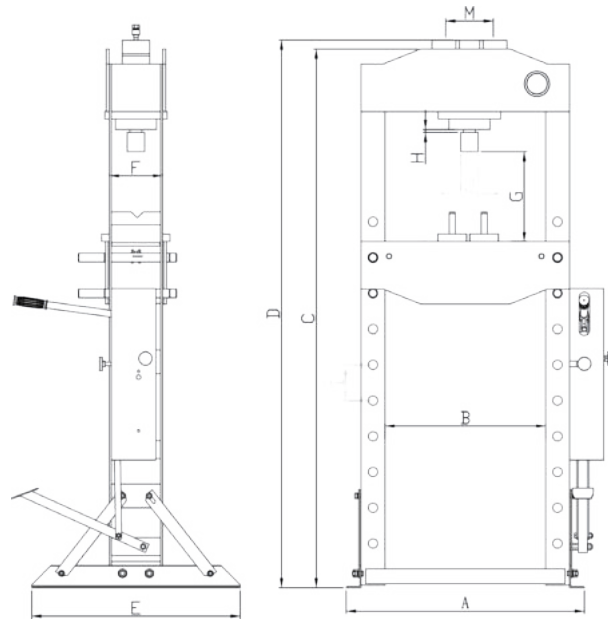

DIMENSÕES (mm)

	A	B	C	D	E	F	G	H	M
FG 742/20TP	760	540	1612	1663	600	140	58-1018	145	180
FG 742/30TP	780	540	1808	1838	740	180	166-1126	150	200
FG 742/50TP	1030	730	1838	1918	740	202	88-1068	220	245

FG 742/20TP

€/LISTA
~~2.200,00~~

PROMO
1.199,00

PRENSA HIDRÁULICA MANUAL Y NEUMÁTICA CON PISTÓN MÓVIL

- Capacidad máxima 20 t
- Funcionamiento en 2 modos: manual con palanca y neumática a pedal
- Pistón móvil con retorno automático
- Manómetro
- Equipado con un par de prismas en V
- Palanca extraíble para funcionamiento manual
- Sistema neumático con funcionamiento a pedal
- Altura de la encimera ajustable

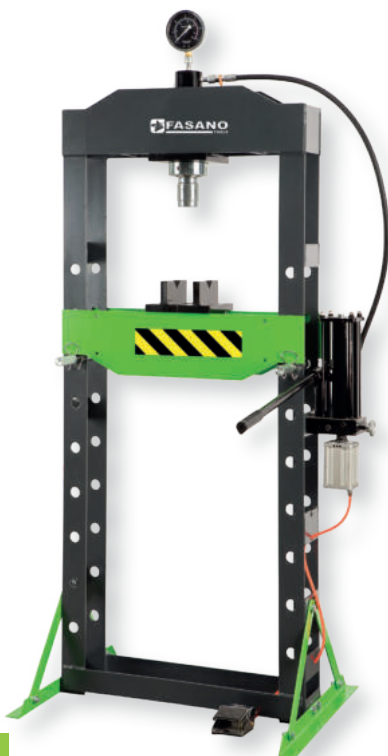

NEW

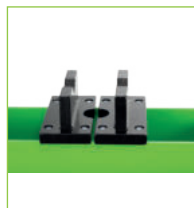

PAR DE PRISMAS EN V



PISTÓN MÓVIL CON RETORNO AUTOMÁTICO

FG 742/30TP

€/LISTA
~~2.650,00~~

PROMO
1.599,00

PRENSA HIDRÁULICA MANUAL Y NEUMÁTICA CON PISTÓN MÓVIL

- Capacidad máxima 30 t
- Funcionamiento en 2 modos: manual con palanca y neumática a pedal
- Pistón móvil con retorno automático
- Manómetro
- Equipado con un par de prismas en V
- Palanca extraíble para funcionamiento manual
- Sistema neumático con funcionamiento a pedal
- Con torno de cuerda para el ajuste de la altura de la encimera

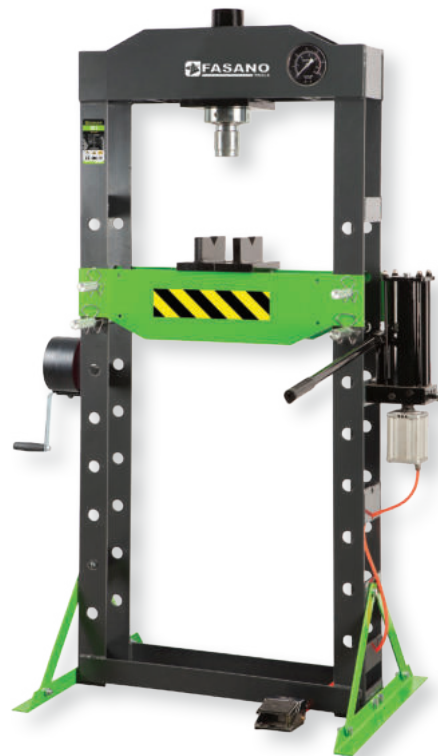

NEW



TORNO DE CUERDA PARA AJUSTE ALTURA DE LA ENCIMERA



PISTÓN MÓVIL CON RETORNO AUTOMÁTICO

FG 742/50TP

€/LISTA
~~4.800,00~~

PROMO
2.799,00

PRESA HIDRÁULICA MANUAL Y NEUMÁTICA CON PISTÓN MÓVIL

Capacidade máxima de 50 t
Opera em 2 modos: manual com alavanca e pneumático com pedal
Pistão móvel com retorno automático
Manómetro
Equipado com um par de prismas em V
Alavanca amovível para operação manual
Sistema pneumático com acionamento por pedal
Com guincho para regulação da altura da mesa de trabalho



NEW



RODO O BOTÃO PARA AJUSTAR A ALTURA DA ENCIMERA



PISTÓN MÓVIL CON RETORNO AUTOMÁTICO

FG 745/CMR

€/LISTA
~~950,00~~

PROMO
569,00€

SUPOORTE DE MOTOR DOBRÁVEL

Versão dobrável
Capacidade de rotação de 360°
Rodas em aço para maior durabilidade e capacidade
L1/mm 995 - L2/mm 585



SISTEMA DE ROTAÇÃO DE 360°



FG 740/0.6T

€/LISTA
~~600,00~~

PROMO
329,00€

ELEVADOR HIDRÁULICO PARA FOSSO E CHASSIS

Sistema de elevação operado por pedal
Equipado com 4 rodízios giratórios em nylon
Válvula de proteção contra sobrecarga
Peso: 26,7 kg - Caudal máximo: 600 kg

NEW



FG 745/CMF

€/LISTA
~~470,00~~

PROMO
269,00€

SUPOORTE DO MOTOR

Capacidade de rotação de 360°
Rodas em aço para maior durabilidade e capacidade
L1/mm 860 - L2/mm 725



SISTEMA DE ROTAÇÃO DE 360°





FG 718/2.5T

€/LISTA
~~479,00~~

PROMO
259,00€

ELEVADOR HIDRÁULICO MODELO CURTO DE 2,5T

- Construção robusta em aço
- Velocidade de descida controlada
- Pega de borracha resistente a impactos
- 4 rodas em nylon
- Válvula de purga de ar

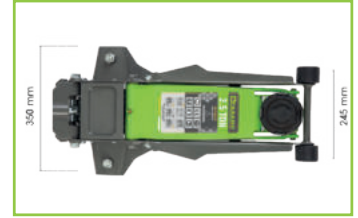

FG 718/3.5T

€/LISTA
~~562,00~~

PROMO
299,00€

ELEVADOR HIDRÁULICO DE 3,5 TONELADAS, MODELO CURTO E BAIXO

- Design discreto, ideal para trabalhar em veículos com baixa altura ao solo
- Elevada capacidade de carga para utilização em SUV e carrinhas
- Construção robusta em aço
- Velocidade de descida controlada
- Punho de borracha resistente a impactos
- 4 rodas em nylon
- Válvula de purga de ar

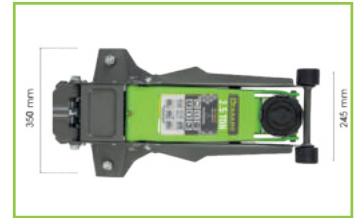

FG 719/2T

€/LISTA

~~740,00~~

PROMO

389,00€

ELEVADOR HIDRÁULICO DE 2 TONELADAS, MODELO LONGO E BAIXO

Design discreto, ideal para trabalhar mesmo em veículos com baixa altura ao solo

Versão longa

Elevação por meio de pega de borracha resistente a impactos

Construção robusta em aço

Velocidade de descida controlada

4 rodas em nylon

Válvula de purga de ar



FG 721/2T

€/LISTA

~~910,00~~

PROMO

479,00€

ELEVADOR HIDRÁULICO DE 2 TONELADAS - MODELO LONGO E DE PERFIL BAIXO COM RODAS BASCULANTES DUPLAS

Ideal também para trabalhar em veículos com baixa altura ao solo.

6 rodas em nylon (4 giratórias)

Pega de elevação com revestimento de borracha absorvente de impacto

Construção robusta em aço

Velocidade de descida controlada

Equipado com válvula de purga de ar

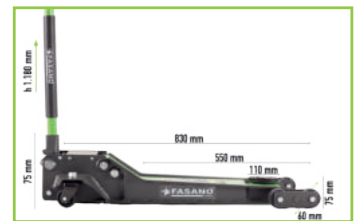

FG 722/5T

€/LISTA

~~1.440,00~~

PROMO

799,00€

EMPILHADOR HIDRÁULICO DE 5 TONELADAS MODELO LONGO

Sistema de aproximação com pedal auxiliar

Rodas de aço montadas em rolamentos de esferas

Mecanismo de retorno automático integrado

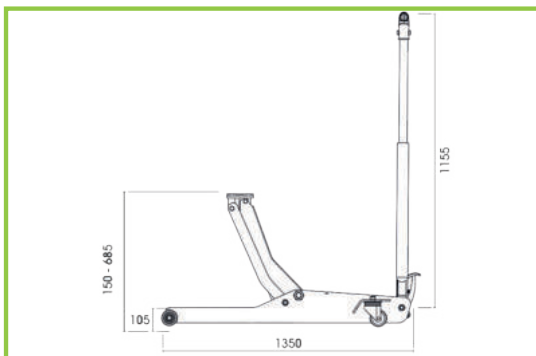

SISTEMA AUXILIAR DE ELEVÇÃO ACIONADO POR PEDAL



RODAS DE AÇO MONTADAS EM ROLAMENTOS DE ESFERAS





FG 213/LT

€/LISTA
~~330,00~~

PROMO
199,00€



FG 213/SM

€/LISTA
~~830,00~~

PROMO
499,00€

TRAVESAÑO INFERIOR DE SOPORTE DEL MOTOR

Útil para soportar el motor o la caja de cambios durante los trabajos de mantenimiento tanto en turismos como en vehículos comerciales



VARILLA EXTENSIBLE PARA FACILITAR EL USO INCLUSO EN VEHÍCULOS CON SOPORTES DE CAMBIO ESPECIALMENTE ANCHOS

PAR DE COLUMNAS DE SOPORTE



CÓDIGO	CAPACIDADE KG	H-MIN/MAX MM	€/LISTA	€/PROMO
FG 725/3T	3000	285-425	100,00	55,90€
FG 725/6T	6000	390-605	170,00	99,00€
FG 725/12T	12000	495-720	300,00	179,00€

MACACOS HIDRÁULICOS DE GARRAFA



CÓDIGO	CAPACIDADE KG	H-MIN/MAX MM	€/LISTA	€/PROMO
FG 735/4T	4000	193-373	85,00	49,00€
FG 735/6T	6000	210-416	98,00	55,00€
FG 735/10T	10000	230-460	142,00	79,00€
FG 735/16T	16000	230-440	168,00	89,00€
FG 735/20T	20000	242-452	210,00	109,00€

FG 750/A

€/LISTA
~~430,00~~

PROMO
259,00€

CARRINHO DE MANUSEAMENTO DE VEÍCULOS

Capacidade 680 Kg
L1/mm: 550 - L2/mm: 620



FG 748/0.5T

€/LISTA
~~250,00~~

PROMO
139,00€

CARRINHO DE MANUSEAMENTO DE VEÍCULOS

Capacidade (kg): 500 - Comprimento (mm): 1550
Sistema de elevação operado por pedal
Equipado com 4 rodízios giratórios



FG 738/1T

€/LISTA
~~1.100,00~~

PROMO
599,00€

GUINDASTE HIDRÁULICO REBATÍVEL

Versão dobrável
Rodas em aço para maior durabilidade e capacidade
Bomba de dupla ação
L/mm: 800 - A/mm: 80



BOMBA DE DUPLO EFEITO

FG 1009/...

CAMISA POLO DE ALGODÃO

Composição: 96% algodão, 4% elastano
Gramagem: 190 g/m²
3 botões

Tamanho M - L - XL



CÓDIGO	€/LISTA	€/PROMO
FG 1009/M	60,00€	35,90€
FG 1009/L	60,00€	35,90€
FG 1009/XL	60,00€	35,90€

FG 1010/...

T-SHIRT DE ALGODÃO

Tecido 100% algodão
Gramagem: 160 g/m²

Tamanho M - L - XL



CÓDIGO	€/LISTA	€/PROMO
FG 1010/M	35,00€	19,90€
FG 1010/L	35,00€	19,90€
FG 1010/XL	35,00€	19,90€

FG 1020/...

CHALECO EN TEJIDO TÉCNICO SOFTSHELL

Confortável, respirável e termorreguladora
Tecido 100% poliéster
Peso: 320 g/m². - Fecho frontal com fecho de correr
2 bolsos exteriores com fecho
+ 2 bolsos interiores
Inserções refletoras nas laterais

Tamanho M - L - XL



CÓDIGO	€/LISTA	€/PROMO
FG 1020/M	165,00€	99,00€
FG 1020/L	165,00€	99,00€
FG 1020/XL	165,00€	99,00€

FG 1022/...

CHAQUETA TÉCNICA SOFTSHELL

Confortável, respirável e termorreguladora.
Tecido 100% poliéster - Gramagem 320 g/m².
Fecho frontal com fecho de correr.
3 bolsos exteriores com fecho.
+ 2 bolsos interiores.
Inserções refletoras nas mangas

Tamanho M - L - XL



CÓDIGO	€/LISTA	€/PROMO
FG 1022/M	215,00€	129,00€
FG 1022/L	215,00€	129,00€
FG 1022/XL	215,00€	129,00€

FG 1015

GORRA CON VISERA

Composição: 65% poliéster, 35% algodão
Tamanho único



€/LISTA	PROMO
18,00	9,90€

FG 1014

GORRO DE INVERNO

Composição 100% acrílico
Com bainha
Tamanho único



€/LISTA	PROMO
28,00	15,90€

FG 1016

GORRA DE 6 PANELES CON VISERA

Tecido 100% poliéster con tejido otomano.
Cierre ajustable con hebilla metálica.

Tamanho único



€/LISTA	PROMO
40,00	22,90€

FG 1012

MOCHILA EM TECIDO TÉCNICO

Compartimento principal amplo com compartimento para portátil
Dois bolsos frontais com fecho e dois bolsos laterais
Painel traseiro e alças de ombro almofadadas
Dimensões: 40 x 30 x 18 cm



€/LISTA	PROMO
68,00	39,90€

CÓDIGO	PÁGINA	€/Pz	CÓDIGO	PÁGINA	€/Pz	CÓDIGO	PÁGINA	€/Pz	CÓDIGO	PÁGINA	€/Pz
FG 58/C250	12	21,90€	FG 58/C250	15	27,90€	FG 100W/6T	56	569,00 €	FG 100BY/AS355	77	1.599,00 €
FG 59XT/S3	12	35,90€	FG 59XT/S3	15	52,90€	FG 100V/7T	56	599,00 €	FG 100GW/AS355	77	1.599,00 €
FG 59XT/S3B	12	27,90€	FG 59XT/S3B	15	59,90€	FG 100B/7T	56	599,00 €	FG 100V/AS56	131	1.499,00 €
FG 59IS/S3	12	49,90€	FG 59IS/S3	16	69,90€	FG 100D/7T	56	599,00 €	FG 100B/AS56	131	1.499,00 €
FG 68/SP	13	39,90€	FG 68/SP	16	21,90€	FG 100R/7T	56	599,00 €	FG 100R/AS56	131	1.499,00 €
FG 68/SP2	13	49,90€	FG 68/SP2	16	14,90€	FG 100W/7T	56	599,00 €	FG 100D/AS56	131	1.499,00 €
FG 68U/S439	13	89,90€	FG 68U/S439	16	179,00€	FG 122V/AS212	64	1.199,00€	FG 100W/AS56	131	1.599,00 €
FG 70/S110	16	36,90€	FG 70/S110	20	199,00€	FG 122B/AS212	64	1.199,00€	FG 100/03G	80	899,00 €
FG 75CO/S25	16	36,90€	FG 75CO/S25	20	159,00€	FG 122R/AS212	64	1.199,00€	FG 100/03G-A	80	999,00 €
FG 77/PVC4	5	24,00€	FG 77/PVC4	21	33,90€	FG 122D/AS212	64	1.199,00€	FG 100/03L	80	899,00 €
FG 81HSS/S3	5	29,00€	FG 81HSS/S3	20	165,00€	FG 100V/AS183	65	1.199,00€	FG 100/03L-A	80	1099,00 €
FG 85/175-S9	5	34,00€	FG 85/175-S9	15	65,00€	FG 100B/AS183	65	1.199,00€	FG 100/03H	80	1799,00 €
FG 85/175-S10	5	49,00€	FG 85/175-S10	15	69,00€	FG 100R/AS183	65	1.199,00€	FG 100/03H-A	80	1899,00 €
FG 88/25-S31	5	75,00€	FG 88/25-S31	14	59,00€	FG 100D/AS183	65	1.199,00€	FG 100/03E	80	619,00 €
FG 92/PM	5	90,00€	FG 92/PM	23	12,90€	FG 100W/AS183	65	1.199,00€	FG 100/03F	80	699,00 €
FG 92/PM4	5	145,00€	FG 92/PM4	23	14,90€	FG 100V/AS371	66	1.399,00€	FG 100/07C	80	659,00 €
FG 92/GR	5	19,00€	FG 92/GR	23	16,90€	FG 100B/AS371	66	1.399,00€	FG 100/07D	80	999,00 €
FG 92/PF	5	27,00€	FG 92/PF	23	15,90€	FG 100R/AS371	66	1.399,00€	FG 100/08C	80	1699,00 €
FG 93/M50	5	42,00€	FG 93/M50	23	18,90€	FG 100D/AS371	66	1.399,00€	FG 100/10C	80	2499,00 €
FG 93/M95	5	36,00€	FG 93/M95	23	18,90€	FG 100W/AS371	66	1.399,00€	FG 100/10D	81	3599,00 €
FG 95/DG	5	49,00€	FG 95/DG	22	57,90€	FG 100V/AS224	73	1.199,00€	FG 100/17	81	799,00 €
FG 95/CA	5	85,00€	FG 95/CA	22	29,90€	FG 100B/AS224	73	1.199,00€	FG 100/17E	81	1699,00 €
FG 96/DG	5	155,00€	FG 96/DG	17	119,00€	FG 100R/AS224	73	1.199,00€	FG 100/18	81	1799,00 €
FG 96/SS36	5	189,00€	FG 96/SS36	24	39,90€	FG 100D/AS224	73	1.199,00€	FG 100/19	81	1399,00 €
FG 97/DG	5	14,90€	FG 97/DG	17	79,00€	FG 100W/AS224	73	1.199,00€	FG 100/21B	81	1499,00 €
FG 97/LT	5	18,00€	FG 97/LT	118	149,00€	FG 122V/AS413	74	1.599,00€	FG 100/21C	81	1499,00 €
FG 98/DG	5	21,00€	FG 98/DG	17	199,00€	FG 122B/AS413	74	1.599,00€	FG 100/21M	81	999,00 €
FG 98/GAS	5	24,00€	FG 98/GAS	24	85,00€	FG 122R/AS413	74	1.599,00€	FG 100/21D	81	999,00 €
FG 98/LT	5	27,00€	FG 98/LT	24	119,00€	FG 122D/AS413	74	1.599,00€	FG 100/21H	81	2699,00 €
FG 98/B	22	6,90€	FG 98/B	118	369,00€	FG 100V/AS230	75	1.499,00€	FG 100/21TX	81	1599,00 €
FG 98/C	22	12,90€	FG 98/C	118	699,00€	FG 100B/AS230	75	1.499,00€	FG 100/81F	81	1199,00 €
FG 98/A1.5	22	15,90€	FG 98/A1.5	119	41,90€	FG 100R/AS230	75	1.499,00€	FG 100/23C	82	1299,00 €
FG 98/A5	22	18,90€	FG 98/A5	119	75,00€	FG 100D/AS230	75	1.499,00€	FG 100/23B	82	2199,00 €
FG 98/A15	23	36,90€	FG 98/A15	119	189,00€	FG 100W/AS230	75	1.499,00€	FG 100/39XT	82	699,00 €
FG 98/A25	21	15,90€	FG 98/A25	119	179,00€	FG 100VD/AS355	77	1.599,00€	FG 100/41C	82	699,00 €
FG 98/A160	21	5,90€	FG 98/A160	119	949,00€	FG 100VW/AS355	77	1.599,00€	FG 100/42C	82	739,00 €
FG 99/DG	21	8,90€	FG 99/DG	17	149,00€	FG 100BW/AS355	77	1.599,00€	FG 100/65B	82	559,00 €
FG 100V/5T	21	11,90€	FG 100V/5T	56	539,00 €	FG 100BD/AS355	77	1.599,00€	FG 100/65C	82	929,00 €
FG 100B/5T	21	18,90€	FG 100B/5T	56	539,00 €	FG 100RD/AS355	77	1.599,00€	FG 100/45D	82	399,00 €
FG 100D/5T	21	28,90€	FG 100D/5T	56	539,00 €	FG 100RY/AS355	77	1.599,00€	FG 100/45E	82	499,00 €
FG 100R/5T	21	17,90€	FG 100R/5T	56	539,00 €	FG 100CW/AS355	77	1.599,00€	FG 100/45F	82	429,00 €
FG 100W/5T	21	38,90€	FG 100W/5T	56	539,00 €	FG 100MA/AS355	77	1.599,00€	FG 100/45G	82	429,00 €
FG 100V/6T	15	64,90€	FG 100V/6T	56	569,00 €	FG 100RW/AS355	77	1.599,00€	FG 100/45I	83	499,00 €
FG 100B/6T	15	69,90€	FG 100B/6T	56	569,00 €	FG 100RB/AS355	77	1.599,00€	FG 100/45T	83	539,00 €
FG 100D/6T	15	84,90€	FG 100D/6T	56	569,00 €	FG 100DP/AS355	77	1.599,00€	FG 100/45H	83	499,00 €
FG 100R/6T	15	84,90€	FG 100R/6T	56	569,00 €	FG 100DW/AS355	77	1.599,00€	FG 100/48G	83	829,00 €

CÓDIGO	PÁGINA	€/Pz	CÓDIGO	PÁGINA	€/Pz	CÓDIGO	PÁGINA	€/Pz	CÓDIGO	PÁGINA	€/Pz
00/51H	83	89,90€	FG 102/41C	70	59,90€	FG 117/CO2D	99	1.899,00€	FG 117V/AS266-60	102	3.699,00€
00/50F	83	54,90€	FG 102/42C	70	65,00€	FG 117/CO2B	99	1.899,00€	FG 117/CO16V	101	1.799,00€
00/50G	83	54,90€	FG 102/45D	70	28,90€	FG 117/CO2R	99	1.899,00€	FG 117/CO16D	101	1.799,00€
00/56C	83	89,90€	FG 102/45E	70	34,90€	FG 117/CO2V-60	99	2.099,00€	FG 117/CO16B	101	1.799,00€
00/54	83	119,00€	FG 102/45F	70	33,90€	FG 117/CO2B-60	99	2.099,00€	FG 117/CO16R	101	1.799,00€
00/76C	83	169,00€	FG 102/45G	70	33,90€	FG 117/CO2D-60	99	2.099,00€	FG 117/CO16V-60	101	1.999,00€
00/03M	84	279,00€	FG 102/45U	70	59,90€	FG 117/CO2R-60	99	2.099,00€	FG 117/CO16B-60	101	1.999,00€
00/21F	86	599,00€	FG 102/45I	71	39,90€	FG 117/CO3V	99	2.399,00€	FG 117/CO16D-60	101	1.999,00€
00/81G	86	499,00€	FG 102/45L	71	41,90€	FG 117/CO3D	99	2.399,00€	FG 117/CO16R-60	101	1.999,00€
00/39E	85	279,00€	FG 102/45T	71	39,90€	FG 117/CO3B	99	2.399,00€	FG 117/CO30V	101	3.699,00€
00/39F	85	249,00€	FG 102/48G	71	73,90€	FG 117/CO3R	99	2.399,00€	FG 117/CO30D	101	3.699,00€
00/45R	84	149,00€	FG 102/50F	71	46,90€	FG 117/CO3V-60	99	2.599,00€	FG 117/CO30B	101	3.699,00€
00/56D	87	229,00€	FG 102/50G	71	46,90€	FG 117/CO3B-60	99	2.599,00€	FG 117/CO30R	101	3.699,00€
00/95B	87	399,00€	FG 102/56C	71	79,90€	FG 117/CO3D-60	99	2.599,00€	FG 117/CO30V-60	101	3.999,00€
00/95C	87	449,00€	FG 102/60D	71	36,90€	FG 117/CO3R-60	99	2.599,00€	FG 117/CO30B-60	101	3.999,00€
00/PR	54	39,00€	FG 102/62B	71	59,90€	FG 117/CO25V	100	2.499,00€	FG 117/CO30D-60	101	3.999,00€
01V/3G	59	249,00€	FG 102/65B	71	41,90€	FG 117/CO25D	100	2.499,00€	FG 117/CO30R-60	101	3.999,00€
01D/AS165	60	699,00€	FG 102/VA1	71	8,90€	FG 117/CO25B	100	2.499,00€	FG 117V/68LVA	105	999,00€
01D/AS196	61	849,00€	FG 102V/AS205	62	999,00€	FG 117/CO25R	100	2.499,00€	FG 117D/68LVA	105	999,00€
02/03G	68	85,00€	FG 102B/AS205	62	999,00€	FG 117/CO25V-60	100	2.699,00€	FG 117R/68LVA	105	999,00€
02/03L	68	89,00€	FG 102R/AS205	62	999,00€	FG 117/CO25B-60	100	2.699,00€	FG 117B/68LVA	105	999,00€
02/03H	68	149,00€	FG 102D/AS205	62	999,00€	FG 117/CO25D-60	100	2.699,00€	FG 117V/68LVA-60	105	1099,00€
02/03E	68	52,90€	FG 104V/AS284	129	1.699,00€	FG 117/CO25R-60	100	2.699,00€	FG 117D/68LVA-60	105	1099,00€
02/03F	68	63,90€	FG 104D/AS284	129	1.699,00€	FG 117/CO24D	100	2.699,00€	FG 117R/68LVA-60	105	1099,00€
02/07C	68	59,90€	FG 104B/AS284	129	1.699,00€	FG 117/CO24V	100	2.699,00€	FG 117B/68LVA-60	105	1099,00€
02/07D	68	83,90€	FG 104R/AS284	129	1.699,00€	FG 117/CO24B	100	2.699,00€	FG 117V/68LVB	105	689,00€
02/08C	68	155,00€	FG 106/B	91	199,00 €	FG 117/CO24R	100	2.699,00€	FG 117D/68LVB	105	689,00€
02/10C	68	209,00€	FG 106/C	91	239,00 €	FG 117/CO24V-60	100	2.899,00€	FG 117R/68LVB	105	689,00€
02/13C	68	119,00€	FG 107/A	91	89,00 €	FG 117/CO24B-60	100	2.899,00€	FG 117B/68LVB	105	689,00€
02/17	69	79,90€	FG BEST 108	8	159,00 €	FG 117/CO24D-60	100	2.899,00€	FG 117V/68LVB-60	105	739,00€
02/17E	69	159,00€	FG 108/B	59	89,00 €	FG 117/CO24R-60	100	2.899,00€	FG 117D/68LVB-60	105	739,00€
02/19	69	119,00€	FG 109/L3	27	169,00 €	FG 117/CO26D	104	2.999,00€	FG 117R/68LVB-60	105	739,00€
02/19B	69	119,00€	FG 111/AS104	25	359,00 €	FG 117/CO26V	104	2.999,00€	FG 117B/68LVB-60	105	739,00€
02/21B	69	139,00€	FG 111/A	25	32,90 €	FG 117/CO26B	104	2.999,00€	FG 118/CO2V	93	2.699,00€
02/21C	69	139,00€	FG 111/B	25	39,90 €	FG 117/CO26R	104	2.999,00€	FG 118/CO2D	93	2.699,00€
02/21E	69	99,00€	FG 111/C	25	49,90 €	FG 117/CO26V-60	104	3.299,00€	FG 118/CO2B	93	2.699,00€
02/21D	69	99,00€	FG 113/A	25	129,00 €	FG 117/CO26B-60	104	3.299,00€	FG 118/CO2R	93	2.699,00€
02/21TX	70	139,00€	FG 113/B	25	139,00 €	FG 117/CO26D-60	104	3.299,00€	FG 118/CO3V	93	3.199,00€
02/21H	69	129,00€	FG 113/C	25	149,00 €	FG 117/CO26R-60	104	3.299,00€	FG 118/CO3D	93	3.199,00€
02/21R	69	139,00€	FG 113/D	25	199,00 €	FG 117D/AS266	102	3.499,00€	FG 118/CO3B	93	3.199,00€
02/25	69	239,00€	FG 117/PVC-1	95	13,90€	FG 117V/AS266	102	3.499,00€	FG 118/CO3R	93	3.199,00€
02/25B	69	239,00€	FG 117/PVC-2	95	4,90€	FG 117B/AS266	102	3.499,00€	FG 118/CO30V	94	3.799,00€
02/23C	70	89,00€	FG 117/PVC-3	95	2,90€	FG 117R/AS266	102	3.499,00€	FG 118/CO30D	94	3.799,00€
02/51H	70	81,90€	FG 117PVC/S5	95	139,00€	FG 117D/AS266-60	102	3.699,00€	FG 118/CO30B	94	3.799,00€
02/39XT	70	59,90€	FG 117PVC/S6	95	169,00€	FG 117R/AS266-60	102	3.699,00€	FG 118/CO30R	94	3.799,00€
02/39D	70	46,90€	FG 117/CO2V	99	1.899,00€	FG 117B/AS266-60	102	3.699,00€	FG 118V/AS351	96	4.999,00€

GO	PÁGINA	€/Pz	CÓDIGO	PÁGINA	€/Pz	CÓDIGO	PÁGINA	€/Pz	CÓDIGO	PÁGINA	€/Pz
18D/AS351	96	4.999,00€	FG 122R/AS217	72	1.099,00€	FG 125D/6G	55	819,00€	FG 137/B1.5	90	739,00€
18B/AS351	96	4.999,00€	FG 122V/AS170	63	1.199,00€	FG 125R/6G	55	819,00€	FG 137/R1.5	90	739,00€
18R/AS351	96	4.999,00€	FG 122B/AS170	63	1.199,00€	FG 125V/7G	55	849,00 €	FG 138/BP	14	399,00€
19V/CO16	106	999,00€	FG 122R/AS170	63	1.199,00€	FG 125B/7G	55	849,00 €	FG 138/M	14	399,00€
19B/CO16	106	999,00€	FG 122D/AS170	63	1.199,00€	FG 125D/7G	55	849,00 €	FG 138	14	399,00€
19R/CO16	106	999,00€	FG 122V/AS402	76	1.599,00€	FG 125R/7G	55	849,00 €	FG 138/B	14	199,00€
19V/CO12	107	1.299,00€	FG 122D/AS402	76	1.599,00€	FG 125/LV	116	11,90€	FG 138/C	14	199,00€
19B/CO12	107	1.299,00€	FG 122B/AS402	76	1.599,00€	FG 125/SB	117	49,00€	FG 139/B	13	99,00€
19R/CO12	107	1.299,00€	FG 122R/AS402	76	1.599,00€	FG 126/S3	23	22,90€	FG 139/C	13	149,00€
19V/CO25	107	1.049,00€	FG 122/PC	54	49,00€	FG 126V/6G	55	899,00 €	FG 139/LM	13	399,00€
19B/CO25	107	1.049,00€	FG 122/PL	54	34,90€	FG 126B/6G	55	899,00 €	FG 139	13	299,00€
19R/CO25	107	1.049,00€	FG 123V/5G	56	739,00€	FG 126D/6G	55	899,00 €	FG 139/L	13	249,00€
19V/CO33	108	1.799,00€	FG 123B/5G	56	739,00€	FG 126R/6G	55	899,00 €	FG 142/S9	13	799,00€
19B/CO33	108	1.799,00€	FG 123D/5G	56	739,00€	FG 126V/7G	55	949,00 €	FG 143TX/S6	14	499,00€
19R/CO33	108	1.799,00€	FG 123R/5G	56	739,00€	FG 126B/7G	55	949,00 €	FG 150TX/S32	9	129,00€
19V/CO18	108	1.099,00€	FG 123V/6G	56	769,00€	FG 126D/7G	55	949,00 €	FG 150M/S26	10	109,00€
19B/CO18	108	1.099,00€	FG 123B/6G	56	769,00€	FG 126R/7G	55	949,00 €	FG 150H/S30	10	199,00€
19R/CO18	108	1.099,00€	FG 123D/6G	56	769,00€	FG 127V/A	59	379,00 €	FG 152/RTXS10	11	999,00€
19V/CO27	109	1.199,00€	FG 123R/6G	56	769,00€	FG 127V/B	59	429,00 €	FG 152RH/S9	11	699,00€
19B/CO27	109	1.199,00€	FG 123V/7G	56	799,00€	FG 128/S11	22	72,90€	FG 152RM/S9	11	699,00€
19R/CO27	109	1.199,00€	FG 123B/7G	56	799,00€	FG 128C/S6	22	28,90€	FG 159/PM	117	139,00€
19M/CO13	109	799,00€	FG 123D/7G	56	799,00€	FG 128/2	88	359,00 €	FG 162/S3	42	299,00€
19M/CO28	109	899,00€	FG 123R/7G	56	799,00€	FG 128/D2	88	489,00 €	FG 162V/14P	57	1.199,00€
20/CO1V	58	1.299,00€	FG 124V/6G	55	659,00 €	FG 128/B2	88	489,00 €	FG 162B/14P	57	1.199,00€
20/CO1D	58	1.299,00€	FG 124B/6G	55	659,00 €	FG 128/R2	88	489,00 €	FG 162D/14P	57	1.199,00€
20/CO1B	58	1.299,00€	FG 124D/6G	55	659,00 €	FG 129/2	88	459,00 €	FG 162R/14P	57	1.199,00€
20/CO1R	58	1.299,00€	FG 124R/6G	55	659,00 €	FG 129/D2	88	599,00 €	FG 162B/14L	57	1.199,00€
20/CO2V	58	1.399,00€	FG 124V/7G	55	699,00 €	FG 129/B2	88	599,00 €	FG 162D/14L	57	1.199,00€
20/CO2D	58	1.399,00€	FG 124B/7G	55	699,00 €	FG 129/R2	88	599,00 €	FG 162R/14L	57	1.199,00€
20/CO2B	58	1.399,00€	FG 124D/7G	55	699,00 €	FG 129/1	89	299,00 €	FG 162V/14L	57	1.199,00€
20/CO2R	58	1.399,00€	FG 124R/7G	55	699,00 €	FG 129/D1	89	369,00 €	FG 162V/AS308	79	2.199,00€
22V/5G	54	539,00€	FG 124D/AS257	67	1.499,00€	FG 129/B1	89	369,00 €	FG 162B/AS308	79	2.199,00€
22B/5G	54	539,00€	FG 124V/AS257	67	1.499,00€	FG 129/R1	89	369,00 €	FG 162R/AS308	79	2.199,00€
22D/5G	54	539,00€	FG 124B/AS257	67	1.499,00€	FG 129/1.5	89	349,00 €	FG 162D/AS308	79	2.199,00€
22R/5G	54	539,00€	FG 124R/AS257	67	1.499,00€	FG 129/D1.5	89	429,00 €	FG 163/S2B	42	199,00€
22V/6G	54	569,00€	FG 124V/AS322	78	1.599,00€	FG 129/B1.5	89	429,00 €	FG 165/IE1	42	199,00€
22B/6G	54	569,00€	FG 124D/AS322	78	1.599,00€	FG 129/R1.5	89	429,00 €	FG 165/IE2	42	499,00€
22D/6G	54	569,00€	FG 124B/AS322	78	1.599,00€	FG 130AL/S5	124	23,90€	FG 165/MB1	43	999,00€
22R/6G	54	569,00€	FG 124R/AS322	78	1.599,00€	FG 130/S10	124	409,00€	FG 165/MB2	43	199,00€
22V/7G	54	599,00€	FG 125/S3	23	43,90€	FG 131/D2	90	899,00€	FG 165/S26	117	499,00€
22B/7G	54	599,00€	FG 125V/5G	55	789,00€	FG 131/B2	90	899,00€	FG 165BC/S6	128	139,00€
22D/7G	54	599,00€	FG 125B/5G	55	789,00€	FG 131/R2	90	899,00€	FG 166/S28	117	299,00€
22R/7G	54	599,00€	FG 125D/5G	55	789,00€	FG 132/D2	90	1.299,00€	FG 166/DS19	128	499,00€
22V/AS217	72	1.099,00€	FG 125R/5G	55	789,00€	FG 132/B2	90	1.299,00€	FG 166/DS24	128	499,00€
22B/AS217	72	1.099,00€	FG 125V/6G	55	819,00€	FG 132/R2	90	1.299,00€	FG 168/EF1	42	299,00€
22D/AS217	72	1.099,00€	FG 125B/6G	55	819,00€	FG 137/D1.5	90	739,00€	FG 168/EF2	42	299,00€

CÓDIGO	PÁGINA	€/Pz	CÓDIGO	PÁGINA	€/Pz	CÓDIGO	PÁGINA	€/Pz	CÓDIGO	PÁGINA	€/Pz
8SD/S4	43	99,00€	FG 182/RG24	126	15,90€	FG 191/S24	113	299,00€	FG 224/L5200	33	139,00€
8A/S5	43	69,00€	FG 183/S5	114	69,90€	FG 191/S14	114	97,90€	FG 225/SK1.5	35	169,00€
8A/S13	43	129,00€	FG 183/RV1	126	12,90€	FG 198/PE	116	39,90€	FG 225/SK2.5	35	189,00€
8EP/S5	43	21,00€	FG 183/CM	127	29,90€	FG 198/S11	117	82,90€	FG 234	34	59,00€
8/S25	43	89,00€	FG 183/CK250	127	13,90€	FG 198/S7	117	49,90€	FG 235	34	79,00€
8/S9	43	119,00€	FG 183/CK450	127	21,90€	FG 198/DF	117	239,00€	FG 236	35	209,00€
8/GA	117	39,90€	FG 183/CK600	127	26,90€	FG 199/PF	116	139,00€	FG 236/SU	35	59,00€
EST 171	8	199,00€	FG 183/RA1	127	15,90€	FG 201	30	29,90€	FGA 290	46	129,00€
1/FL	123	32,90€	FG 184/S5	119	109,00€	FG 201/S7	112	209,00€	FGA 291/D	46	129,00€
1/N	123	21,50€	FG 184/S4	123	61,90€	FG 202	28	34,90€	FGA 292/B	46	139,00€
2/BS	116	149,00€	FG 184P/S3	124	15,90€	FG 202/PV	111	145,00€	FG 305/LT2	38	529,00€
2/FA	122	39,90€	FG 184R/S3	125	28,90€	FG 203	28	12,90€	FGA 307	44	149,00€
2/PA	122	45,90€	FG 184/R1	125	12,90€	FG 203/S20	112	219,00€	FGA 307/AN	44	199,00€
2/MA	122	59,90€	FG 184/R2	125	13,90€	FG 203/BW1	112	22,90€	FGA 309	44	179,00€
2/AS2	122	75,00€	FG 185P/S4	120	17,90€	FG 203/FO1	112	22,90€	FG 310/LT2	38	559,00€
2/TC	122	19,90€	FG 185B/S2	125	24,90€	FG 203/FO2	112	22,90€	FGA 312	44	219,00€
2/TG	122	29,90€	FG 185/S5	125	59,90€	FG 203/FT1	112	27,90€	FG 315/LT2	38	599,00€
2/RL2	123	15,90€	FG 185/CR	126	6,90€	FG 203/OP1	112	22,90€	FGA 316	45	459,00€
2/GO2	123	69,90€	FG 185/OM	126	19,90€	FG 203/TO1	112	22,90€	FGA 316/L	45	529,00€
2/OT	123	33,90€	FG 185/RM	126	19,90€	FG 203/S7	112	104,58€	FGA 319	45	699,00€
2/CA	123	34,90€	FG 186P/S4	116	14,90€	FG 204	28	19,90€	FGA 319/L	45	739,00€
4/SC	114	74,90€	FG 186P/S5	125	19,90€	FG 205/C	31	79,00€	FG 320/LT2	39	669,00€
5/S30	110	139,00€	FG 186/S5	125	59,90€	FG 205/B	31	49,90€	FGA 321	45	659,00€
5/PR	110	24,90€	FG 186/AL1	125	15,90€	FG 206	30	33,90€	FGA 321/B	45	689,00€
5/PF/S4	110	48,90€	FG 186/S4	125	16,90€	FG 207	29	38,90€	FGA 321/C	45	719,00€
5/S114	111	169,00€	FG 186/S3	126	6,90€	FG 207/B	29	59,90€	FGA 322	46	899,00€
5/S15	111	85,00€	FG 186/S3B	126	6,90€	FG 209	33	149,00€	FG 325/LT2	39	549,00€
5/S4	111	45,90€	FG 187/GU	127	17,90€	FG 210/C	32	99,00€	FG 330/LT2	37	549,00€
6/S13	112	269,00€	FG 187/S7	127	139,00€	FG 210/W	32	47,90€	FGA 330	49	179,00€
8/UF	110	37,90€	FG 187/GR	127	17,90€	FG 210/B	33	49,90€	FGA 332	49	899,00€
8/UF83	111	21,90€	FG 187/GU2	127	16,90€	FG 211	29	59,90€	FGA 334	50	899,00€
8/FL	111	28,90€	FG 187/K40	127	119,00€	FG 212	29	43,90€	FGA 334/AN115	50	1099,00€
8/UF110	111	75,00€	FG 187/S2	128	479,00€	FG 213/B	30	89,00€	FGA 334/AN	50	1099,00€
8/UF145	111	109,00€	FG 187/PN	128	169,00€	FG 213/L480	30	39,90€	FGA 334/L	50	1099,00€
8/BF	115	159,00€	FG 188/P1	124	11,90€	FG 213/LT	138	199,00€	FG 335/LT2	37	599,00€
8/S6	115	199,00€	FG 188P/S2	124	24,90€	FG 213/SM	138	499,00€	FGA 335	49	1299,00€
9/SF	115	1.099,00€	FG 188P/S4	128	44,90€	FG 214/L600	28	42,90€	FGA 336	49	4099,00€
9/ST	122	15,90€	FG 189/PO1	126	12,90€	FG 215/S40	120	899,00€	FGA 337	49	799,00€
0/SP9	3	129,00€	FG 189/PO2	126	23,90€	FG 217/B	31	179,00€	FGA 338	50	799,00€
1RE/S2	114	53,90€	FG 190/RI	113	36,90€	FG 219/S	120	1.999,00€	FGA 338/AN	50	1099,00€
1/C14	114	19,90€	FG 190/IP	113	29,90€	FG 220/BT	121	249,00€	FGA 338/L	50	1099,00€
1/PM2	122	49,00€	FG 190/OP	113	27,90€	FG 220/EN	121	299,00€	FGA 339	49	2199,00€
2/S5B	43	289,00€	FG 190/RE	113	149,00€	FG 221	32	159,00€	FGA 340	48	1799,00€
2/S14	43	149,00€	FG 190/S8	113	49,90€	FG 222/A	32	49,00€	FGA 340/B	48	1899,00€
2/S16	114	339,00€	FG 190/S6B	114	99,00€	FG 222/B	32	169,00€	FGA 342/B	48	1799,00€
2/RG10	126	11,90€	FG 191/S22	113	389,00€	FG 224/SU	33	49,00€	FGA 342	48	1399,00€

CÓDIGO	PÁGINA	€/Pz
343/N10	48	149,00€
343/N20	48	199,00€
344	48	159,00€
346/B	50	149,00€
348/A	51	109,00€
348/B	51	129,00€
348/C	51	159,00€
348/D	51	179,00€
350/LT1	40	299,00€
353/LT1	40	319,00€
356/LT1	40	319,00€
350/LT1	41	379,00€
353/LT1	41	369,00€
350/LT1	41	319,00€
353/LT1	41	299,00€
383/AR15	47	149,00€
385/AR15	47	199,00€
390	46	99,00€
396	47	14,90€
399	47	15,90€
401/200	112	24,90€
401/1500	112	53,90€
401/DF1500	112	79,90€
403/AL	24	29,90€
403/N	24	23,90€
404/S12	24	34,90€
404/A180	24	119,00€
406	18	135,00€
403/2	18	149,00€
406/1	18	149,00€
406/2	18	159,00€
406/3	18	189,00€
408/1	18	529,00€
408/2	18	559,00€
409/1	18	699,00€
410/1	18	629,00€
410/2	18	739,00€
410/3	18	849,00€
413/DG1	19	429,00€
413/DG2	19	499,00€
414/1	19	119,00€
414/2	19	129,00€
414/3	19	139,00€
414/4	19	169,00€
416/DG	19	199,00€
417/DG	19	125,00€

CÓDIGO	PÁGINA	€/Pz
FG 581/A	19	559,00€
FG 581/B	19	789,00€
FG 600/SC16	2	139,00€
FG 600/SC25	2	219,00€
FG 600A/SC16	2	159,00€
FG 600A/SC25	2	249,00€
FG 600L/SC10	2	99,00€
FG 600XL/SC7	3	165,00€
FG 600TW/S12	3	119,00€
FG 600E/S4	3	33,90€
FG 602/SC13	3	95,00€
FG 603/S28A	130	559,00€
FG 603/S28B	130	559,00€
FG 603/TA1	131	179,00€
FG 605/ST11-B	5	142,50€
FG 606/SP9	5	89,00€
FG 610FL/SP9	5	149,00€
FG 615/SC8	3	69,00€
FG 615A/S6	5	75,00€
FG 618/S7B	4	159,00€
FG 618/S7	4	179,00€
FG 618/S10	4	249,00€
FG 621H/S8C	4	99,00€
FG 621TX/S13	4	149,00€
FG 622A/S2	5	49,00€
FG 623H/S6	4	85,00€
FG 623H/S8	4	119,00€
FG 623H/S14	4	239,00€
FG 624/S25	6	52,90€
FG 625/S15	6	69,00€
FG 625/S110	7	269,00€
FG 625/S27	7	109,00€
FG 625TX/S77	9	179,00€
FG 628/S6	11	59,00€
FG 628/S12	11	79,00€
FG 628/S7	116	69,90€
FG 628/R17.5	116	12,90 €
FG 628/R18.5	116	12,90 €
FG 628/R21.5	116	13,90 €
FG 628/R22.5	116	13,90 €
FG 628/R27.5	116	15,90 €
FG 629A/S15	10	339,00€
FG 629B/S15	10	339,00€
FG 629C/S10	11	179,00€
FG 630A/S14	11	499,00€
FG 718/2.5T	136	259,00 €

CÓDIGO	PÁGINA	€/Pz
FG 718/3.5T	136	299,00 €
FG 719/2T	137	389,00 €
FG 721/2T	137	479,00 €
FG 722/5T	137	799,00 €
FG 725/3T	138	55,90 €
FG 725/6T	138	99,00 €
FG 725/12T	138	179,00 €
FG 735/4T	138	49,00 €
FG 735/6T	138	55,00 €
FG 735/10T	138	79,00 €
FG 735/16T	138	89,00 €
FG 735/20T	138	109,00 €
FG 738/1T	138	599,00 €
FG 740/0.6T	135	329,00 €
FG 742/20TP	134	1.199,00 €
FG 742/30TP	134	1.599,00 €
FG 742/50TP	135	2.799,00 €
FG 745/CMR	135	569,00 €
FG 745/CMF	135	269,00 €
FG 748/0.5T	138	139,00 €
FG 750/A	138	259,00 €
FG 750/1P	133	1.599,00 €
FG 750/2P	133	1.899,00 €
FG 752/1P	133	1.799,00 €
FG 752/2P	133	2.099,00 €
FG 1425	27	61,90€
FG 1426	27	71,90€
FG 1427	27	99,00€
FG 1433	27	119,00€
FG 1434	27	86,90€
FG 1440	27	35,90€
FG 1445	27	29,90€
FG 1450	26	84,90€
FG 1452	26	99,00€
FG 1454	26	129,00€
FG 1456	26	159,00€
FG 1460	26	99,00€
FG 1465	26	119,00€
FG 1009/M	139	35,90€
FG 1009/L	139	35,90€
FG 1009/XL	139	35,90€
FG 1010/M	139	19,90€
FG 1010/L	139	19,90€
FG 1010/XL	139	19,90€
FG 1020/M	139	99,00€
FG 1020/L	139	99,00€

CÓDIGO	PÁGINA	€/Pz
FG 1020/XL	139	99,00€
FG 1022/M	139	129,00€
FG 1022/L	139	129,00€
FG 1022/XL	139	129,00€
FG 1015	139	9,90€
FG 1016	139	22,90€
FG 1014	139	15,90€
FG 1012	139	39,00€



DISTRIBUIDOR OFICIAL

FASANGAS S.r.l.

SEDE LEGALE E LOGISTICA

Viale Grecia 3, lotto 18
- 73100 Zona Ind.le LECCE - ITALY

SEDE PRODUTTIVA

Viale Irlanda 3 - 73100
Zona Ind.le LECCE - ITALY
(+39) 0832.362097/364265

info@fasanotools.com



VALIDADE:
02-02-2026 / 31-01-2027

FASANOTOOLS.COM



 **FASANO**
TOOLS